

The logo for GOSHE, featuring the word "GOSHE" in a white, bold, sans-serif font. The text is contained within a white, stylized shape that resembles a speech bubble or a drop, with a curved top and a pointed bottom. The background of the top section is a solid orange color with some water droplets scattered across it.

GOSHE

Wersja cennika: 01/2026 z dnia 23.03.2026 r.

OFERTA CENOWA 2026

The background of the lower two-thirds of the page is a close-up photograph of water droplets on a surface. The droplets are of various sizes and are arranged in a way that creates a sense of depth and movement. The color of the droplets transitions from a light blue on the left to a warm orange on the right, matching the overall color scheme of the document. The bottom of the page features a dark blue and grey gradient bar.



Baterie łazienkowe i kuchenne Goshe posiadające gwarancję objęte są procedurą „**Serwis 48h**” gwarantującą reakcję sieci serwisowej Goshe Sp. z o. o. w ciągu 2 dni roboczych (48h) od daty zgłoszenia reklamacji.

Zgłoszenia reklamacyjne dokonujemy:

- telefonicznie 89 545 90 27, 664 327 590
- elektronicznie e-mailem na adres **serwis@goshe.pl**,
- listownie na adres firmy:

Goshe Sp. z o. o. ul. Zientary-Malewskiej 41A, 10-307 Olsztyn.



NOTATKI:

A large, rounded rectangular area with a light gray background and horizontal lines, intended for taking notes.

SPIS TREŚCI

1. ARMATURA WODNA

Zawory kulowe STANDARD	grupa A	5
Zawory kulowe MINI	grupa A	5
Zawory kulowe PREMIUM	grupa A	5
Zawory kulowe PREMIUM GRAND	grupa A	6
Zawory czepalne	grupa A	6
Pozostałe zawory kulowe	grupa A	6
Zawory kątowe i podłączeniowe	grupa A	7
Filtry do wody	grupa A	8
Reduktor ciśnienia wody	grupa A	8
Zawory zwrotne	grupa A	8
Zasuwki wodne	grupa A	8
Zawory ocynkowane	grupa B	8
Zawory antyskażeniowe	grupa A	9
Akcesoria do wodomierzy	grupa H, C3	9

2. ARMATURA GAZOWA

Przyłącza elastyczne do gazu	grupa B	9
Zawory gazowe	grupa B	9

3. PRZYŁĄCZA ELASTYCZNE DO WODY

Wężyki PEX w oplocie stalowym	grupa B3	10
Wężyki w oplocie stalowym	grupa B	11

4. ARMATURA GRZEWCZA

Zawory odpowietrzające automatyczne	grupa B	11
Zawory odpowietrzające ręczne	grupa B	11
Zawory grzejnikowe	grupa B	12
Zawory termostatyczne	grupa B	13
Główce termostatyczne	grupa B	14
Zawory różnicowe	grupa B	14
Zawory spustowe	grupa B	14
Zawory bezpieczeństwa	grupa B	10, 14
Zawory mieszające	grupa C1	14
Siłownik do zaworu mieszającego	grupa C1	14
Wymienniki płytowe	grupa C1	14
Pompy	grupa C1	15
Rozdzielacze do C.O.	grupa B	15
Akcesoria do rozdzielaczy	grupa B	15

5. ASORTYMENT DO RUR WIELOWARSTWOWYCH

Złączki skręcane	grupa E	16
Złączki zaprasowywane zacisk typ u	grupa E	17
Narzędzia montażowe REMS	grupa L	17
Złączki zaprasowywane zacisk typ u/th	grupa E	18
Rura PeRT-AL-PeRT	grupa H	19
Akcesoria	grupa D	19

6. KSZTAŁTKI MOSIĘŻNE

Złączki mosiężne	grupa B	20
------------------	---------	----

7. KSZTAŁTKI ŻELIWNE OCYNKOWANE

Złączki żeliwne	grupa A	23
-----------------	---------	----

7. KSZTAŁTKI MOSIĘŻNE CHROMOWANE

Złączki chromowane	grupa B	26
--------------------	---------	----

8. AKCESORIA DO RUR

Obejmy	grupa D1	27
--------	----------	----

9. ARMATURA POMIAROWA

Manometry	grupa B	28
Termometry	grupa B	28
Termomanometry	grupa B	28

10. BATERIE ŁAZIENKOWE

Seria INEZ	grupa F	29
Seria LIRA	grupa F	29
KUCHENNE	grupa F	30
Seria GERA	grupa F	31
Seria LETA	grupa F	31
Seria MONITA	grupa F	32
Seria PERLA	grupa F	32
Seria STANDARD	grupa F	33
Seria RETRO	grupa F	33
Podtynkowa OSLO	grupa F	35

11. AKCESORIA ŁAZIENKOWE

Deszczownice	grupa I	35
Wężki prysznicowe	grupa I	35
Zestawy natryskowe	grupa I	36
Drażki natryskowe	grupa I	36
Zawieszania do słuchawek	grupa I	36
Słuchawki prysznicowe	grupa I	37
Korki	grupa I	38
Perlatory	grupa I	39
Bateria czasowa	grupa I	39
Syfony	grupa B	40
Złącza WC	grupa B	40
Akcesoria do baterii	grupa I, I1	40
Wylewki do baterii	grupa I	41
Części serwisowe do baterii	grupa I	41





Zawory kulowe Premium [z dławikiem]

GOSHE PN 30 / P 3,0 MPa / T 180°C

ZAWÓR KULOWY WW RĄCZKA GRUPA A



Indeks	wymiar	cena netto	pak
0200.050	3/8"	15,64	14/140
0200.051	1/2"	20,22	12/96
0200.052	3/4"	29,02	10/80
0200.053	1"	47,96	8/48
0200.054	1 1/4"	71,02	6/24
0200.055	1 1/2"	101,62	4/24
0200.056	2"	164,72	2/16

ZAWÓR KULOWY WZ RĄCZKA GRUPA A



Indeks	wymiar	cena netto	pak
0200.065	1/2"	20,74	12/96
0200.066	3/4"	30,06	10/80
0200.067	1"	47,60	8/48

ZAWÓR KULOWY ZE ŚRUBUNKIEM SAMOUSZCZELNIAJĄCYM GRUPA A



Indeks	wymiar	cena netto	pak
0200.080	1"	68,54	6/48

ZAWÓR KULOWY WW MOTYL GRUPA A



Indeks	wymiar	cena netto	pak
0200.061	1/2"	19,50	20/160
0200.062	3/4"	28,80	14/84
0200.063	1"	49,18	8/64

ZAWÓR KULOWY WZ MOTYL GRUPA A



Indeks	wymiar	cena netto	pak
0200.071	1/2"	20,76	12/120
0200.072	3/4"	30,08	10/80
0200.073	1"	49,16	8/64

ZAWÓR KULOWY ZE ŚRUBUNKIEM GRUPA A



Indeks	wymiar	cena netto	pak
0200.076	1/2"	26,30	12/96
0200.077	3/4"	39,00	8/64
0200.078	1"	63,86	6/48

ZAWÓR KULOWY ZE ŚRUBUNKIEM Z RĄCZKĄ GRUPA A



Indeks	wymiar	cena netto	pak
0200.057	1/2"	26,30	12/96
0200.058	3/4"	39,00	8/64
0200.059	1"	65,88	6/48

Zawory kulowe Premium Grand [z dławikiem]

PN 30 / P 3,0 Mpa / T 180°C

ZAWÓR KULOWY WW RĄCZKA GRUPA A



Indeks	wymiar	cena netto	pak
0200.100	3/8"	15,64	14/140
0200.101	1/2"	20,22	12/96
0200.102	3/4"	29,02	10/80
0200.103	1"	47,96	8/48
0200.104	1 1/4"	71,02	6/24
0200.105	1 1/2"	101,62	4/24
0200.106	2"	164,72	2/16

ZAWÓR KULOWY WZ RĄCZKA GRUPA A



Indeks	wymiar	cena netto	pak
0200.115	1/2"	20,74	12/96
0200.116	3/4"	30,06	10/80
0200.117	1"	47,60	8/48

ZAWÓR KULOWY ZE ŚRUBUNKIEM SAMOUSZCZELNIAJĄCYM GRUPA A



Indeks	wymiar	cena netto	pak
0200.133	1"	68,54	6/48

ZAWÓR KULOWY WW MOTYL GRUPA A



Indeks	wymiar	cena netto	pak
0200.111	1/2"	19,50	20/160
0200.112	3/4"	28,80	14/84
0200.113	1"	49,18	8/64

ZAWÓR KULOWY WZ MOTYL GRUPA A



Indeks	wymiar	cena netto	pak
0200.121	1/2"	20,76	12/120
0200.122	3/4"	30,08	10/80
0200.123	1"	49,16	8/64

ZAWÓR KULOWY ZE ŚRUBUNKIEM GRUPA A



Indeks	wymiar	cena netto	pak
0200.126	1/2"	26,30	12/96
0200.127	3/4"	39,02	8/64
0200.128	1"	63,86	6/48
0200.129 z rączką	1 1/4"	103,76	6/24

Armatura WODNA

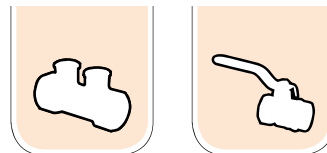

Zawory kulowe Standard [z dławikiem]

PN 16 / P 1,6 MPa / T 120°C

ZAWÓR KULOWY WW RĄCZKA GRUPA A

Indeks	wymiar	cena netto	pak
0200.082	3/4"	22,80	10/80
0200.083	1"	36,60	8/64
0200.084	1 1/4"	59,10	4/32
0200.085	1 1/2"	85,90	4/32
0200.086	2"	133,08	2/16

ZAWÓR KULOWY WW MOTYL GRUPA A

Indeks	wymiar	cena netto	pak
0200.091	3/4"	22,20	10/100
0200.092	1"	37,46	8/80

ZAWÓR KULOWY WZ MOTYL GRUPA A

Indeks	wymiar	cena netto	pak
0200.097	3/4"	23,72	10/80
0200.098	1"	38,46	8/64

GOSHE [PN 10/P 1,0 MPa / T 65/ dop. 90°C przez 1 h]

ZAWÓR KULOWY WW RĄCZKA GRUPA A

Indeks	wymiar	cena netto	pak
0200.088	3"	418,14	2/6
0200.089	4"	749,30	2/4

ZAWÓR KULOWY WZ RĄCZKA GRUPA A

Indeks	wymiar	cena netto	pak
0200.094	3/4"	24,12	10/80
0200.095	1"	37,34	8/64

Zawory kulowe Mini

GOSHE PN 10

ZAWÓR KULOWY MINI ZE ZŁĄCZKĄ NA RURĘ PEX-AL-PEX GRUPA A

Indeks	wymiar	cena netto	pak
0200.045	16x1/2" niebieski	16,88	20/200

ZAWÓR KULOWY MINI GRUPA A

Indeks	wymiar	cena netto	pak
0200.049	1/2" ww	18,04	25/250

Zawory czerpalne

GOSHE PN 10

ZAWÓR KULOWY CZERPALNY Z DŁAWIKIEM GRUPA A

Indeks	wymiar	cena netto	pak
0200.042	3/4"	25,04	8/80
0200.043	1"	45,46	6/60

GOSHE PN 10

ZAWÓR KULOWY CZERPALNY Z SZYBKOZŁĄCZKĄ GRUPA A

Indeks	wymiar	cena netto	pak
0200.036	3/4"	26,20	8/64

ZAWÓR CZERPALNY GRZYBKOWY GRUPA A

Indeks	wymiar	rodzaj	cena netto	pak
0200.033	3/4"	mosiądz	42,82	1/50

ZAWÓR CZERPALNY GRZYBKOWY GRUPA A

Indeks	wymiar	rodzaj	cena netto	pak
0200.031	3/4"	chrom	45,54	1/50





Zawory kulowe z nakrętką

GOSHE PN 10

ZAWÓR KULOWY Z NAKRĘTKĄ	GRUPA A			
Indeks	wymiar	cena netto	pak	
0200.364	1/2"	22,52	15/120	
0200.365	3/4"	35,30	8/80	
0200.366	1"	57,18	6/48	



ZAWÓR KULOWY KĄTOWY Z NAKRĘTKĄ	GRUPA A			
Indeks	wymiar	cena netto	pak	
0200.375	1/2"	24,50	12/96	
0200.376	3/4"	41,48	10/60	
0200.377	1"	67,80	4/40	

Pozostałe zawory kulowe

ZAWÓR KULOWY Z ODPOWIETRZNIKIEM	GRUPA A			
Indeks	wymiar	cena netto	pak	
0200.372	1/2"	34,74	10/100	
0200.373	3/4"	47,20	10/60	
0200.374	1"	55,04	8/40	



ZAWÓR KULOWY PODTYNKOWY	GRUPA A			
Indeks	wymiar	cena netto	pak	
0200.370	1/2"	57,52	5/50	
0200.371	3/4"	69,28	4/40	

ZAWÓR KULOWY DO WLUTOWANIA	GRUPA A			
Indeks	wymiar	cena netto	pak	
0200.360	15	16,60	16/160	
0200.361	18	21,66	12/120	
0200.362	22	30,70	10/100	
0200.363	28	44,36	6/60	



ZAWÓR KULOWY KĄTOWY ZE ŚRUBUNKIEM	GRUPA A			
Indeks	wymiar	cena netto	pak	
0200.340	1/2"	29,54	10/60	
0200.341	3/4"	42,70	10/60	
0200.342	1"	74,26	8/40	

ZAWÓR KULOWY Z GNIAZDEM DO CZUJNIKA TEMPERATURY	GRUPA A			
Indeks	wymiar	cena netto	pak	
0200.357	1/2 M10x1	25,56	12/120	



ZAWÓR KULOWY KĄTOWY ZE ŚRUBUNKIEM PREMIUM	GRUPA A			
Indeks	wymiar	cena netto	pak	
0200.338	1"	83,46	4/40	

Zasuwy wodne

ZASUWA WODNA	GRUPA A			
Indeks	wymiar	cena netto	pak	
0200.380	1/2"	19,66	10/100	
0200.381	3/4"	27,40	10/100	
0200.382	1"	38,48	8/64	
0200.383	1 1/4"	65,66	5/30	
0200.384	1 1/2"	88,72	4/24	
0200.385	2"	105,34	2/24	



ZAWÓR PRZELOTOWY GRZYBKOWY OCYNKOWANY	GRUPA B			
Indeks	wymiar	cena netto	pak	
0200.409	1/2"	18,36	8/72	
0200.410	3/4"	23,84	8/48	
0200.411	1"	35,74	6/36	
0200.412	1 1/4"	63,78	3/18	
0200.413	1 1/2"	85,46	1/12	
0200.414	2"	147,24	1/8	



ZAWÓR KULOWY Z FILTREM OSADNIKOWYM PREMIUM	GRUPA A			
Indeks	wymiar	cena netto	pak	
0200.347	1"	68,72	4/24	



ZAWÓR CZERPALNY GRZYBKOWY OCYNKOWANY	GRUPA B			
Indeks	wymiar	cena netto	pak	
0200.418	1/2"	20,68	6/48	
0200.419	3/4"	30,54	5/30	



ZAWÓR KULOWY Z FILTREM OSADNIKOWYM	GRUPA A			
Indeks	wymiar	cena netto	pak	
0200.350	1/2"	30,84	10/100	
0200.351	3/4"	46,06	6/60	
0200.352	1"	56,44	4/40	



ZAWÓR ZWROTNY ŻELIWNY - ARMATURA	GRUPA B			
Indeks	wymiar	cena netto	pak	
0200.433	1"	58,10	8/48	



GŁOWICA ZAWORU PRZELOTOWEGO GRZYBKOWEGO	GRUPA B			
Indeks	wymiar	cena netto	pak	
0200.400	1/2"	11,98	10/120	
0200.401	3/4"	15,52	10/100	
0200.402	1"	21,10	8/80	
0200.403	1 1/4"	41,10	5/50	
0200.404	1 1/2"	52,62	4/40	
0200.405	2"	90,40	2/20	



REDUKTOR CIŚNIENIA Z MANOMETREM

GRUPA A



Indeks	wymiar	cena netto	pak
0350.300	1/2"	101,64	1/30
0350.302	3/4"	111,38	1/30
0350.304	1	121,08	1/30

GOSHE FUTURE TECH

REDUKTOR CIŚNIENIA GFT RCS

GRUPA A



Indeks	wymiar	cena netto	pak
0350.312	3/4"	129,98	1/20

REDUKTOR CIŚNIENIA GFT RCS ze śrubunkiem

GRUPA A



Indeks	wymiar	cena netto	pak
0350.322	3/4"	161,90	1/20

GOSHE FUTURE TECH

Zawór kątowy grzybkowy z filtrem Maestro

GRUPA A

indeks	wymiar	cena netto	pak.
0500.203	1/2"x3/8"	35,96	1/100
0500.204	1/2"x1/2"	36,92	1/100
0500.205	1/2"x3/4"	37,88	1/100



Zawór kątowy kulowy antykamienny Hyper

indeks	wymiar	cena netto	pak.
0500.233	1/2"x3/8"	17,66	1/100
0500.234	1/2"x1/2"	17,98	1/100
0500.235	1/2"x3/4"	18,52	1/100



Zawór kątowy kombinowany Hyper Combi

indeks	wymiar	cena netto	pak.
0500.239	1/2"x3/4"x3/8"	42,28	1/100



Zawory kątowe i połączeniowe

GOSHE PN 10

ZAWÓR KĄTOWY KULOWY GRUPA A



Indeks	wymiar	cena netto	pak
0200.200	1/2"×3/8"	16,36	1/100
0200.201	1/2"×1/2"	16,66	1/100
0200.202	1/2"×3/4"	17,98	1/100

ZAWÓR KĄTOWY GRZYBKOWY GRUPA A



Indeks	wymiar	cena netto	pak
0200.210	1/2"×3/8"	17,72	1/100
0200.211	1/2"×1/2"	18,48	1/100
0200.212	1/2"×3/4"	20,14	1/100

ZAWÓR KĄTOWY KULOWY Z FILTREM GRUPA A



metalowa rączka

Indeks	wymiar	cena netto	pak
0200.218	1/2"×3/8"	17,96	1/100
0200.219	1/2"×1/2"	18,06	1/100
0200.220	1/2"×3/4"	19,36	1/100

ZAWÓR KĄTOWY GRZYBKOWY PREMIUM GRUPA A



Indeks	wymiar	cena netto	pak
0200.214	1/2"×3/8"	18,94	1/100
0200.215	1/2"×1/2"	20,05	1/100
0200.216	1/2"×3/4"	20,95	1/100

ZAWÓR KĄTOWY KULOWY ANTYKAMIENNY GRUPA A



Indeks	wymiar	cena netto	pak
0200.207	1/2"×3/8"	16,36	1/100
0200.208	1/2"×1/2"	16,66	1/100
0200.209	1/2"×3/4"	17,98	1/100

ZAWÓR KĄTOWY Z GŁOWICĄ CERAMICZNĄ PREMIUM GRUPA A



Indeks	wymiar	cena netto	pak
0200.230	1/2"×3/8" niebieski	29,68	1/100
0200.231	1/2"×3/8" czerwony	29,68	1/100
0200.232	1/2"×1/2" niebieski	30,52	1/100
0200.234	1/2"×1/2" czerwony	30,52	1/100
0200.233	1/2"×3/4" niebieski	33,64	1/100

ZAWÓR KĄTOWY KULOWY PREMIUM GRUPA A



Indeks	wymiar	cena netto	pak
0200.224	1/2"×3/8"	17,02	1/100
0200.225	1/2"×1/2"	17,68	1/100
0200.226	1/2"×3/4"	18,88	1/100

ZAWÓR KĄTOWY Z GŁOWICĄ CERAMICZNĄ GRUPA A



Indeks	wymiar	cena netto	pak
0200.235	1/2"×3/8"	24,86	1/100
0200.236	1/2"×1/2"	25,88	1/100
0200.237	1/2"×3/4"	27,10	1/100

ZAWÓR KĄTOWY KULOWY Z FILTREM PREMIUM GRUPA A



Indeks	wymiar	cena netto	pak
0200.221	1/2"×3/8"	24,90	1/100
0200.222	1/2"×1/2"	25,16	1/100
0200.223	1/2"×3/4"	26,28	1/100

ZAWÓR KĄTOWY KULOWY ANTYKAMIENNY Z FILTREM PREMIUM GRUPA A



Indeks	wymiar	cena netto	pak
0200.227	1/2"×3/8"	24,90	1/100
0200.228	1/2"×1/2"	25,16	1/100
0200.229	1/2"×3/4"	26,28	1/100

ZAWÓR GRZYBKOWY DO PODŁĄCZENIA PRAŁKI Z PRZEDŁUŻKĄ PREMIUM GRUPA A



ruchoma nakrętka

Indeks	wymiar	cena netto	pak
0200.244	3/4"	46,98	1/50

ZAWÓR KOMBINOWANY GRUPA A



Indeks	wymiar	cena netto	pak
0200.240	1/2"×3/4"×10	46,02	1/50

ZAWÓR GRZYBKOWY DO PODŁĄCZENIA PRAŁKI Z PRZEDŁUŻKĄ GRUPA A



Indeks	wymiar	cena netto	pak
0200.242	3/4"	41,78	1/50
0200.243	przedłużka 3/4"×50	18,56	20/200

ZAWÓR KOMBINOWANY MINI GRUPA A



Indeks	wymiar	cena netto	pak
0200.241	1/2"×3/4"×10	40,36	1/50

Armatura WODNA

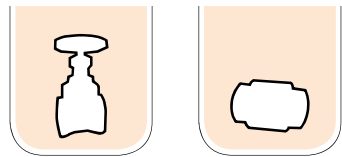

Zawory zwrotne

GOSHE PN 10

ZAWÓR ZWROTNY GRUPA A



Indeks	wymiar	cena netto	pak
0200.180	1/2"	14,28	20/200
0200.181	3/4"	18,34	10/100
0200.182	1"	25,68	6/60
0200.183	1 1/4"	46,04	9/90
0200.184	1 1/2"	56,92	4/40

ZAWÓR ZWROTNY - MOSIĘŻNY GRZYB GRUPA A



Indeks	wymiar	cena netto	pak
0200.170	1/2"	17,08	20/200
0200.171	3/4"	22,82	10/100
0200.172	1"	34,88	6/60
0200.173	1 1/4"	52,30	6/60
0200.174	1 1/2"	78,22	4/40
0200.175	2"	104,68	2/20
0200.176	2 1/2"	184,46	2/20
0200.177	3"	284,94	2/10

Akcesoria do wodomierzy

KPL. ŚRUBUNKÓW DO WODOMIERZA GOSHE GRUPA H



Indeks	wymiar	cena netto	pak
0120.050	1/2"	15,58	20/200
0120.051	3/4"	24,96	15/150
0120.052	1"	50,08	12/120

KPL. ŚRUBUNKÓW DO WODOMIERZA (INNY PRODUCENT) GRUPA H



Indeks	wymiar	cena netto	pak
100.906	1/2"	18,75	1
100.905	3/4"	27,90	1
100.919	1"	53,58	1
100.917	1 1/4"	90,30	1
100.918	1 1/2"	134,14	1
100.913	2"	238,86	1
100.909	1/2" krótkie L25	24,52	1
100.925	3/4" krótkie L26"	33,46	1

REDUKCJA DO WODOMIERZA GRUPA H



Indeks	wymiar	cena netto	pak
0120.030	1x3/4"	7,50	10/400

PRZEDŁUŻKA DO WODOMIERZA GRUPA C3



Indeks	wymiar	cena netto	pak
0120.019	L-60	32,56	18/180

KONSOLA DO WODOMIERZA PREMIUM - GOSHE GRUPA H



Indeks	wymiar	cena netto	pak
0120.000	1/2"	136,58	1/20
0120.001	3/4"	174,46	1/20

KONSOLA DO WODOMIERZA - GOSHE GRUPA H



Indeks	wymiar	cena netto	pak
0120.015	1/2"	131,14	1/20
0120.016	3/4"	134,46	1/20

ZAWÓR ZWROTNY Z KOSZEM SSĄCYM GRUPA A



Indeks	wymiar	cena netto	pak
0200.150	1/2"	13,82	20/200
0200.151	3/4"	16,86	15/150
0200.152	1"	22,44	8/64
0200.153	1 1/4"	34,98	8/64
0200.154	1 1/2"	48,64	3/30
0200.155	2"	77,22	3/30

ZAWÓR ZWROTNY WZ GRUPA A



Indeks	wymiar	cena netto	pak
0200.140	1/2"	14,28	20/200

KOSZ SSĄCY GRUPA A



Indeks	wymiar	cena netto	pak
0201.680	1/2"	2,40	40/400
0201.681	3/4"	3,62	26/260
0201.682	1"	4,42	15/150
0201.683	1 1/4"	6,58	12/120
0201.684	1 1/2"	8,06	6/60
0201.685	2"	12,74	4/40

ZAWÓR ZWROTNY KLAPOWY GRUPA A



Indeks	wymiar	cena netto	pak
0200.160	1/2"	26,42	10/100
0200.161	3/4"	27,46	10/100
0200.162	1"	41,86	6/60
0200.163	1 1/4"	77,48	3/30
0200.164	1 1/2"	108,14	2/20
0200.165	2"	174,16	2/20

Zawory antyskażeniowe

GOSHE PN 10

ZAWÓR ANTYSKAŻENIOWY GRUPA A



Indeks	wymiar	cena netto	pak
0120.080	1/2"	20,60	20/200
0120.081	3/4"	26,64	12/120
0120.082	1"	40,36	10/100

Filtry do wody

GOSHE PN 10

FILTR OSADNIKOWY DO WODY GRUPA A



Indeks	wymiar	cena netto	pak
0200.190	1/2"	14,36	20/200
0200.191	3/4"	21,38	10/100
0200.192	1"	42,72	6/60
0200.193	1 1/4"	72,02	5/50
0200.194	1 1/2"	103,30	2/20
0200.195	2"	154,88	2/20

FILTR OSADNIKOWY DO WODY STANDARD GRUPA A



Indeks	wymiar	cena netto	pak
0200.196	1/2"	11,56	20/200
0200.197	3/4"	18,44	10/100
0200.198	1"	27,06	60/60



Separatory

SEPARATOR MAGNETYCZNY - GOSHE

GRUPA B



Indeks	wymiar	cena netto	pak
0350.720	3/4"x3/4"x3/4"	142,50	1/12



0350.721	1"x1"x1"	313,92	1/6
----------	----------	--------	-----



0350.722	1 1/4"x1 1/4"x1 1/4"	363,70	1/3
----------	-------------------------	--------	-----

ZAWÓR KĄTOWY Z SEPARATOREM MAGNETYCZNYM - GOSHE

GRUPA B



Indeks	wymiar	cena netto	pak
0350.730	3/4"	77,50	1/20

Zawór strefowy

3-DROGOWY ZAWÓR STREFOWY

GRUPA A



Indeks	wymiar	cena netto	pak
0350.125	3X1" GZ	429,08	1/18
0350.128	3x1 1/4 GZ	451,82	1/18

Grupy bezpieczeństwa INOX

GRUPA BEZPIECZEŃSTWA

GRUPA C



Indeks	wymiar	cena netto	pak
0210.556	1,5 bar	148,74	1
0210.557	2,5 bar	148,74	1
0210.558	3,0 bar	148,74	1
0210.559	6,0 bar	148,74	1

GRUPA BEZPIECZEŃSTWA - Z ZAWOREM STOPOWYM

GRUPA C



0210.550	1,5 bar	168,00	1
0210.551	2,5 bar	168,00	1
0210.552	3,0 bar	168,00	1
0210.553	6,0 bar	168,00	1

ZAWÓR ZWROTNY Z ZAWOREM STOPOWYM

GRUPA B















Indeks	wymiar	cena netto	pak
0210.570	3/4"	24,72	1





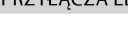

Przyłącza elastyczne PEX w oplocie stalowym do wody

PN 10



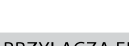
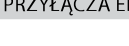

PRZYŁĄCZA ELASTYCZNE PEX 1/2"x1/2" WW GRUPA B

	Indeks	wymiar	cena netto	pak
	0555.340	L 20	7,26	10/250
	0555.341	L 25	7,72	10/250
	0555.342	L 30	7,82	10/250
	0555.343	L 35	8,51	10/200
	0555.344	L 40	8,65	10/200
	0555.346	L 50	9,50	10/200
	0555.348	L 60	10,73	10/200
	0555.350	L 70	11,81	10/100
	0555.352	L 80	12,20	10/100
	0555.354	L 100	14,27	10/100
	0555.360	L 150	18,76	10/50
	0555.362	L 200	20,67	10/50







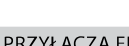



PRZYŁĄCZA ELASTYCZNE PEX 1/2"x3/8" ww GRUPA B

	Indeks	wymiar	cena netto	pak
	0555.388	L 20	6,86	10/250
	0555.390	L 30	7,90	10/250
	0555.392	L 40	8,48	10/200
	0555.394	L 50	9,21	10/200
	0555.396	L 60	10,29	10/200
	0555.398	L 80	11,97	10/100











PRZYŁĄCZA ELASTYCZNE PEX 3/8"x3/8" ww GRUPA B

	Indeks	wymiar	cena netto	pak
	0555.302	L 20	6,84	10/400
	0555.304	L 30	7,42	10/250
	0555.306	L 40	8,30	10/250
	0555.308	L 50	8,94	10/250
	0555.310	L 60	10,02	10/250

PRZYŁĄCZA ELASTYCZNE PEX M10x3/8" GRUPA B

	Indeks	wymiar	cena netto	pak
	0555.320	L 30 długie	7,52	2/250
	0555.322	L 30 krótkie	6,76	2/250
	0555.324	L 40 długie	8,18	2/250
	0555.326	L 40 krótkie	7,50	2/250
	0555.328	L 50 długie	9,20	2/250
	0555.330	L 50 krótkie	8,50	2/250
	0555.332	L 60 długie	9,94	2/250
	0555.334	L 60 krótkie	8,80	2/250
	0555.336	L 80 długie	11,30	2/100
	0555.338	L 80 krótkie	10,90	2/100

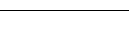
PRZYŁĄCZA ELASTYCZNE PEX M10x1/2" GRUPA B

	Indeks	wymiar	cena netto	pak
	0555.364	L 30 długie	9,34	2/250
	0555.366	L 30 krótkie	7,08	2/250
	0555.368	L 40 długie	8,70	2/200
	0555.370	L 40 krótkie	7,80	2/200
	0555.372	L 50 długie	9,10	2/200
	0555.374	L 50 krótkie	8,36	2/250
	0555.376	L 60 długie	10,00	2/200
	0555.378	L 60 krótkie	9,26	2/200
	0555.382	L 80 długie	11,82	2/100
	0555.384	L 80 krótkie	11,08	2/100

Zawory odpowietrzające automatyczne

ODPOWIETRZNIK AUTOMATYCZNY 1/2" MOSIĘŻNY GRUPA B

	Indeks	wymiar	cena netto	pak
	0200.291**	prosty	16,54	1/100

ODPOWIETRZNIK AUTOMATYCZNY 1/2" kątowy GRUPA B

	Indeks	wymiar	cena netto	pak
	0200.299*	mosiądz	14,80	1/100

ODPOWIETRZNIK AUTOMATYCZNY 1/2" MOSIĘŻNY GRUPA B

	Indeks	wymiar	cena netto	pak
	0200.292*	niski	18,16	1/120



ZAWÓR STOPOWY 1/2" MOSIĘŻNY GRUPA B

	Indeks	wymiar	cena netto	pak
	0200.298	1/2"/1/2"	4,80	1/100

ODPOWIETRZNIK AUTOMATYCZNY 1/2" CHROMOWANY GRUPA B

	Indeks	wymiar	cena netto	pak
	0200.290*	prosty	16,98	1/100

ODPOWIETRZNIK GRZEJNIKA 1" GRUPA B

	Indeks	wymiar	cena netto	pak
	0200.294	lewy	19,46	1/100
	0200.295	prawy	19,46	1/100

* bez zaworu stopowego
** z zaworem stopowym



Przyłącza elastyczne w oplocie stalowym do wody

PN 10

PRZYŁĄCZA ELASTYCZNE 1/2"x3/8" ww GRUPA B

Indeks	wymiar	cena netto	pak
0200.980	L 20	6,58	10/250
0200.982	L 30	7,54	10/250
0200.984	L 40	8,18	10/200
0200.986	L 50	8,82	10/200
0200.988	L 60	9,46	10/200
0200.990	L 80	10,86	10/100

PRZYŁĄCZA ELASTYCZNE 3/8"x3/8" ww GRUPA B

Indeks	wymiar	cena netto	pak
0200.852	L 20	6,52	10/400
0200.854	L 30	7,08	10/250
0200.856	L 40	7,70	10/250
0200.858	L 50	8,56	10/250
0200.860	L 60	9,58	10/250
0200.862	L 80	11,96	10/250

PRZYŁĄCZA ELASTYCZNE M10x1/2" GRUPA B

Indeks	wymiar	cena netto	pak
0200.950	L 30 długie	7,48	2/250
0200.952	L 30 krótkie	6,72	2/250
0200.954	L 40 długie	8,14	2/250
0200.956	L 40 krótkie	7,44	2/250
0200.958	L 50 długie	8,62	2/250
0200.960	L 50 krótkie	7,90	2/250
0200962	L 60 długie	9,22	2/250
0200964	L 60 krótkie	8,58	2/250
0200.966	L 80 długie	10,80	2/100
0200.968	L 80 krótkie	10,08	2/100

PRZYŁĄCZA ELASTYCZNE 1/2"x1/2" ww GRUPA B

Indeks	wymiar	cena netto	pak
0200.902	L 20	6,88	10/250
0200.903	L 25	7,50	10/250
0200.904	L 30	7,54	10/250
0200.905	L 35	8,08	10/200
0200.906	L 40	8,18	10/200
0200.908	L 50	8,82	10/200
0200.910	L 60	9,76	10/200
0200.912	L 70	10,74	10/200
0200.914	L 80	11,10	10/100
0200.915	L 90	12,06	10/100
0200.916	L 100	12,96	10/100
0200.918	L 120	14,76	10/100
0200.924	L 150	17,06	10/100
0200.932	L 200	18,78	10/50

PRZYŁĄCZA ELASTYCZNE M10x3/8" GRUPA B

Indeks	wymiar	cena netto	pak
0200.870	L 30 długie	7,12	2/250
0200.872	L 30 krótkie	6,36	2/250
0200.873	L 35 krótki	6,72	2/250
0200.871	L 35 długie	7,48	2/250
0200.874	L 40 długie	7,82	2/250
0200.876	L 40 krótkie	7,12	2/250
0200.878	L 50 długie	8,72	2/250
0200.880	L 50 krótkie	8,08	2/250
0200.882	L 60 długie	9,46	2/250
0200.884	L 60 krótkie	8,54	2/250
0200.889	L 70 długie	10,22	2/100
0200.890	L 70 krótkie	9,50	2/100
0200.886	L 80 długie	11,08	2/100
0200.888	L 80 krótkie	10,40	2/100

Zawory odpowietrzające ręczne

PN 10

ODPOWIETRZNIK NA KLUCZYK GRUPA B

Indeks	wymiar	cena netto	pak
0200.305	1/2"	2,80	20/60/ 1000
0200.304	kluczyk metalowy	0,86	1/100

KOREK Z ORINGIEM GRUPA B

Indeks	wymiar	cena netto	pak
0200.310	1/2"	2,36	50/600

ODPOWIETRZNIK RĘCZNY GRUPA B

Indeks	wymiar	cena netto	pak
0200.306	1/2"	4,62	50/500

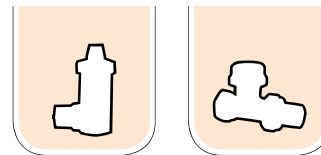

Zawory grzejnikowe

GOSHE PN 10

ZESPÓŁ PRZYŁĄCZY DO GRZEJNIKA 3/4" PROSTY GRUPA B

Indeks	wymiar	cena netto	pak
0200.282	z nyplami	40,38	8/80



NYPEŁ DO ZESPOŁU PRZYŁĄCZY GRUPA B

Indeks	wymiar	cena netto	pak
0200.248		4,26	1



ZESPÓŁ PRZYŁĄCZY DO GRZEJNIKA 3/4" KĄTOWY GRUPA B

Indeks	wymiar	cena netto	pak
0200.283	z nyplami	36,20	8/80



ADAPTER DO ZESPOŁU PRZYŁĄCZY GRUPA B

Indeks	wymiar	cena netto	pak
700.721		3,28	1



ZAWÓR GRZEJNIKOWY Z DŁAWIKIEM PREMIUM GRUPA B

Indeks	wymiar	cena netto	pak
0200.256	1/2" prosty	27,70	10/100



ZAWÓR GRZEJNIKOWY ODCINAJĄCY 1/2" PREMIUM GRUPA B

Indeks	wymiar	cena netto	pak
0200.276	prosty	23,18	12/120



ZAWÓR GRZEJNIKOWY 1/2" Z DŁAWIKIEM PREMIUM GRUPA B

Indeks	wymiar	cena netto	pak
0200.257	kątowy	26,96	10/100



ZAWÓR GRZEJNIKOWY ODCINAJĄCY 1/2" PREMIUM GRUPA B

Indeks	wymiar	cena netto	pak
0200.277	kątowy	22,54	12/120



ZAWÓR GRZEJNIKOWY PROSTY GRUPA B

Indeks	wymiar	cena netto	pak
0200.252	1/2"	19,86	15/150
0200.254	3/4"	31,48	8/80



ZAWÓR GRZEJNIKOWY ODCINAJĄCY PROSTY GRUPA B

Indeks	wymiar	cena netto	pak
0200.271	3/8"	18,36	20/200
0200.272	1/2"	18,10	20/200
0200.274	3/4"	29,18	20/200



ZAWÓR GRZEJNIKOWY KĄTOWY GRUPA B

Indeks	wymiar	cena netto	pak
0200.253	1/2"	19,98	15/150



ZAWÓR GRZEJNIKOWY ODCINAJĄCY GRUPA B

Indeks	wymiar	cena netto	pak
0200.273	kątowy 1/2"	16,62	20/200



ZAWÓR GRZEJNIKOWY ODCINAJĄCY DO WLUTOWANIA GRUPA B

Indeks	wymiar	cena netto	pak
0200.278	prosty 1/2"	15,92	20/100



Zawory termostaticzne

ZAWÓR TERMOSTATYCZNY 1/2" GRUPA B



Indeks	wymiar	cena netto	pak
0200.287	prosty	27,06	10/100

ZAWÓR TERMOSTATYCZNY 1/2" GRUPA B



Indeks	wymiar	cena netto	pak
0200.288	kątowy	27,06	10/100

ZAWÓR TERMOSTATYCZNY Z KOŃCÓWKĄ ZACISKOWĄ GRUPA B



zacisk
pex ϕ 16

Indeks	wymiar	cena netto	pak
0200.268	zasilający termostaticzny	30,86	10/100

ZAWÓR TERMOSTATYCZNY KĄTOWY 1/2" GRUPA B



Indeks	wymiar	cena netto	pak
0200.260	lewy	31,40	10/100

ZAWÓR TERMOSTATYCZNY KĄTOWY 1/2" GRUPA B



Indeks	wymiar	cena netto	pak
0200.261	prawy	31,40	10/100

Zestawy termostaticzne

ZESTAW TERMOSTATYCZNY PROSTY T-03 GRUPA B



Indeks	wymiar	cena netto	pak
0200.323	prosty	58,66	1/50

ZESTAW TERMOSTATYCZNY PROSTY GRUPA B



Indeks	wymiar	cena netto	pak
0200.296	prosty	69,88	1/50

ZESTAW TERMOSTATYCZNY KĄTOWY GRUPA B



Indeks	wymiar	cena netto	pak
0200.297	kątowy	68,90	1/50

ZESTAW TERMOSTATYCZNY KĄTOWY T-03 GRUPA B



Indeks	wymiar	cena netto	pak
0200.324	kątowy	57,90	1/50

ZESTAW TERMOSTATYCZNY Z GOWICĄ KIRA GRUPA B



Indeks	wymiar	cena netto	pak
0300.082	kątowy	67,10	1/40



Armatura GRZEWCZA

Zestawy termostatyczne





ZESTAW TERMOSTATYCZNY OSIOWY GRUPA B

	Indeks	kolor	rodzaj	cena netto	pak
	0300.204	chrom		122,24	1/20
	0300.203	czarny		122,24	1/20
	0300.206	biały	PRAWY	138,22	1/20
	0300.207	czarny MAT		129,18	1/20
	0300.210	chrom		122,24	1/20
	0300.209	czarny		122,24	1/20
	0300.212	biały	LEWY	138,22	1/20
	0300.213	czarny MAT		129,18	1/20





ZESTAW TERMOSTATYCZNY PROSTY COMBO GRUPA B

	Indeks	wymiar	cena netto	pak
	0300.217	biały	133,16	1/20
	0300.218	czarny mat	133,16	1/20

ZESTAW TERMOSTATYCZNY KĄTOWY GRUPA B











	Indeks	wymiar	cena netto	pak
	0300.315	chrom	126,70	1/20
	0300.314	czarny	118,40	1/20
	0300.317	biały	137,16	1/20
	0300.318	czarny mat	137,16	1/20

ZŁĄCZKA 15 (KPL - 2 SZT.) GRUPA B



	Indeks	wymiar	cena netto	pak
	0300.115	chrom	15,64	1/150
	0300.114	czarny	15,64	1/150
	0300.117	biały	15,64	1/150
	0300.118	czarny mat	15,64	1/150

Zawór termostatyczny





ZAWÓR TERMOSTATYCZNY ZESPOLONY-1-OTWOROWY GRUPA B

	Indeks	kolor	rodzaj	cena netto	pak
	0300.330	chrom		156,52	1/20
	0300.329	czarny		156,52	1/20
	0300.332	biały	PRAWY	162,88	1/20
	0300.333	czarny MAT		162,88	1/20
	0300.339	chrom		156,52	1/20
	0300.338	czarny		156,52	1/20
	0300.341	biały		162,88	1/20
	0300.342	czarny MAT	LEWY	162,88	1/20





GŁOWICA TERMOSTATYCZNA KIRA GRUPA B

	Indeks	wymiar	cena netto	pak
	0300.030	M30x1,5 czarna	23,58	1/100
	0300.032	M30x1,5 biała	23,58	1/100

KOMPLET MASKUJĄCY ZESPOLONY GRUPA B

	Indeks	wymiar	cena netto	pak
	0300.120	chromm	32,54	1/40
	0300.119	czarny	32,54	1/40
	0300.122	biały	32,92	1/40
	0300.123	czarny mat	32,92	1/40

KOMPLET MASKUJĄCY GRUPA B

	Indeks	wymiar	cena netto	pak
	0300.125	chrom	24,18	1/40
	0300.124	czarny	24,18	1/40
	0300.127	biały	25,36	1/40
	0300.128	czarny mat	25,36	1/40

Zawory spustowe, bezpieczeństwa

ZAWÓR BEZPIECZEŃSTWA DO BOJLERA GRUPA B



Indeks	wymiar	cena netto	pak
0200.300	1/2"	11,48	20/200
0200.301	3/4"	19,66	10/100

ZAWÓR SPUSTOWY Z KOŃCÓWKĄ NA WAŻ I KORKIEM GRUPA B



Indeks	wymiar	cena netto	pak
0200.135	1/2" niebieski +oring	12,50	20/200
0200.136	1/2" czerwony +oring	12,50	20/200
0200.137	1/2" niebieski	12,50	20/200
0200.138	1/2" czerwony	12,50	20/120
0200.139	3/4"	26,00	10/120

Zawory różnicowe

ZAWÓR RÓŻNICOWY - GOSHE GRUPA B



Indeks	wymiar	cena netto	pak
0460.400	1"	34,56	1/24
0460.401	1 1/4"	37,80	1/18
0460.402	1 1/2"	48,12	1/16
0460.403	2"	60,74	1/12

Głowice do zaworów termostatycznych

GŁOWICA TERMOSTATYCZNA GRUPA B



Indeks	wymiar	cena netto	pak
0200.289	M30x1,5	23,58	1/100

GŁOWICA TERMOSTATYCZNA Z BLOKADĄ NASTAWY GRUPA B



Indeks	wymiar	cena netto	pak
0200.286	M30x1,5	27,64	1/100

Wymienniki płytowe

WYMIENNIK PŁYTOWY GRUPA C1



Indeks	wymiar	cena netto	pak
0350.620	1'20 kw	580,04	1
0350.630	1'30 kw	747,20	1
0350.640	1'40 kw	914,34	1
0350.650	1'50 kw	1082,74	1

IZOLACJA WYMIENNIKA GRUPA C



Indeks	wymiar	cena netto	pak
0350.660	B3 15,20,30	136,08	1
0350.661	B3 40, 50	170,10	1

Zawory mieszające

ZAWÓR MIESZAJĄCY GWINTOWANY EMIX - GOSHE GRUPA C1



Indeks	wymiar	cena netto	pak
0360.325	3-drogowy DN 25, gw	106,62	1/12
0360.332	3-drogowy DN 32, gw	129,92	1/12
0360.425	4-drogowy DN 25, gw	129,58	1/12
0360.432	4-drogowy DN 32, gw	145,20	1/9



SŁOWNIK DO ZAWORU MIESZAJĄCEGO EMIX 401 - GOSHE GRUPA C



Indeks	wymiar	cena netto	pak
0350.504		248,80	1
603.501	Śruba M6 x26 do mocowania na zaworze Wormix	1,42	1

GŁOWICA TERMOSTATYCZNA - CRYSTAL COLOR GRUPA B



Indeks	wymiar	cena netto	pak
0300.016	RÓŻOWA	18,38	1/100
0300.018	FIOLETOWA	18,38	1/100



GŁOWICA TERMOSTATYCZNA GRUPA B



Indeks	wymiar	cena netto	pak
0200.322	M30x1,5	20,88	1/100

Armatura GRZEWCZA - POMPY

GRUPA C

APM 32/80

Indeks	Wymiary (mm)	H (m)*	Cena netto
0400.005	32/180	8	542,85



GOSHE FUTURE TECH

GFT Xtreme

Indeks	Wymiary (mm)	H (m)*	Cena netto
0400.010	25/180	4 6	428,55
0400.011	25/130	4 6	428,55



GFT Xcompaq

Indeks	Wymiary (mm)	H (m)*	Cena netto
0400.040	25/180	4	414,29
0400.042	25/180	6	428,57
0400.044	25/130	6	428,57
0400.046	25/180	8	528,57



GFT Xprime

Indeks	Wymiary (mm)	H (m)*	Cena netto
0400.050	25/180	6	278,50
0400.052	25/180	8	285,50



ELEKTRONICZNA POMPA DO CYRKULACJI CIEPŁEJ WODY UŻYTKOWEJ CWU

GFT Xwave

Indeks	Wymiary (mm)	H (m)*	Cena netto
0400.026	15/80	1,5	407,14

*H (m) - wysokość podnoszenia



ELEKTRONICZNE POMPY OBIEGOWE

Xtreme

- 25-40|60-180
- 25-40|60-130



- medium: woda;
- maksymalny przepływ: 2800 l/h lub 3600 l/h;
- pobór mocy P1 (W): 3,8-35;
- napięcie zasilania: 1x230V 50 Hz;
- poziom ciśnienia akustycznego: <43 dB (A);
- rodzaj ochrony: IP42;
- klasa cieplna: TF 110;
- temperatura otoczenia: 0°C do 40°C;
- temperatura medium: 5°C do 110°C;
- maksymalne ciśnienie robocze: 10 bar.
- współczynnik efektywności energetycznej (EEI): ≤0,20;

- **DWUZAKRESOWA** pompa Xtreme umożliwia pracę w trybie 4 m lub 6 m wysokości podnoszenia.
- Funkcja **AUTO Smart Adapt** optymalizuje pracę pompy, dostosowując ją do aktualnych warunków w instalacji grzewczej lub wodnej. Prowadzi to do oszczędności energii i wygody użytkowania.
- **7 trybów** pracy manualnej.
- Praca w trybie nocnym.
- Pompa wyposażona w **wyświetlacz** wskazujący chwilowe zużycie energii i wybrane nastawy pracy.
- Funkcja **autoodpowietrzania** zapewnia długotrwałą prawidłową pracę pompy.
- **Automatyczny** rozruch wirnika.
- Izolacja w komplecie.

Xcompaq

- 25-40-180
- 25-60-180
- 25-60-130
- 25-80-180



- medium: woda;
- napięcie zasilania: 1x 230V 50-60 Hz;
- pobór mocy P1 (W): 3,8-35;
- poziom ciśnienia akustycznego: <45 dB(A);
- rodzaj ochrony: IP42;
- klasa cieplna: TF 110;
- temperatura otoczenia: 0°C do 4°C;
- temperatura medium: +2°C~+110°C
- maksymalne ciśnienie robocze: 10 bar
- współczynnik efektywności energetycznej (EEI): 40 i 60 EEI ≤0,20; 80 EEI ≤0,21

- **Ergonomiczna** pompa o niedużych wymiarach umożliwia montaż w ograniczonych przestrzeniach.
- Funkcja **AUTO Smart Adapt** optymalizuje pracę pompy, dostosowując ją do aktualnych warunków w instalacji grzewczej lub wodnej.
- Prowadzi to do **oszczędności energii** i wygody użytkowania.
- **7 trybów** pracy manualnej.
- Praca w trybie nocnym.
- Pompa wyposażona w **wyświetlacz** wskazujący chwilowe zużycie energii i wybrane nastawy pracy.
- Funkcja **autoodpowietrzania** zapewnia długotrwałą prawidłową pracę pompy.
- **Automatyczny** rozruch wirnika.
- Izolacja w komplecie.

Xprime

- 25-60-180
- 25-80-180



- medium: woda;
- napięcie zasilania: 1x 230V 50-60 Hz;
- pobór mocy P1 (W): 5-65;
- rodzaj ochrony: IP44;
- klasa cieplna: TF 110;
- poziom ciśnienia akustycznego: <45 dB(A);
- temperatura otoczenia: 0°C do 40°C;
- temperatura medium: +2°C~+110°C;
- maksymalne ciśnienie robocze: 10 bar;
- współczynnik efektywności energetycznej (EEI): 60 EEI ≤0,20; 80 EEI ≤0,21

- Pompa z **kablem PWM**, który pozwala na regulację prędkości obrotowej pompy za pomocą sygnału elektrycznego. Sygnał **PWM** steruje pracą silnika pompy, wpływa to na moc dostarczaną do pompy i w konsekwencji wydajność.
- Funkcja **AUTO SmartAdapt** optymalizuje pracę pompy, dostosowując ją do aktualnych warunków w instalacji grzewczej lub wodnej. Prowadzi to do oszczędności energii i wygody użytkowania.
- **7 trybów** pracy manualnej.
- Praca w trybie nocnym.
- Funkcja **autoodpowietrzania** zapewnia długotrwałą prawidłową pracę pompy.
- **Automatyczny** rozruch wirnika.
- Izolacja w komplecie.

ELEKTRONICZNA POMPA DO CYRKULACJI CIEPLEJ WODY UŻYTKOWEJ CWU

Xwave

- 15-1,5



- medium: woda;
- napięcie zasilania: 1x 230V 50-60 Hz;
- gwint przyłączeniowy 1/2";
- pobór mocy P1 (W): 9;
- poziom ciśnienia akustycznego: < 45 dB (A);
- rodzaj ochrony: IP44;
- klasa cieplna: TF 95;
- temperatura medium: +2°C~+70°C;
- maksymalne ciśnienie robocze: 10 bar.

- Mosiężny korpus;
- Funkcja **rozruchu** po postoju;
- Produkt z atestem PZH;
- Tryb odpowietrzania;
- Płynna regulacja pracy;
- Pompa posiada pokrętko do regulacji obrotów;



Moduł mieszający do rozdzielaczy podłogowych (rozstaw 235) - GOSHE

MODUŁ MIESZAJĄCY z pompą Goshe, Xtreme GRUPA C



Indeks	wymiar	cena netto	pak
0401.606	zawór GOSHE kv 2,5	834,00	1
0401.607	zawór GOSHE kv 3,6	1054	1

MODUŁ MIESZAJĄCY z pompą Xcompaq GRUPA C



Indeks	wymiar	cena netto	pak
0401.604	zawór GOSHE kv 2,5	834,00	
0401.605	zawór GOSHE kv 3,6	1054,00	1

MODUŁ MIESZAJĄCY z pompą Xprime GRUPA C



Indeks	wymiar	cena netto	pak
0401.609	zawór GOSHE KV2,5	784,00	1
0401.610	zawór GOSHE KV3,8	1004,00	1

MODUŁ MIESZAJĄCY z pompą Wita GRUPA C



Indeks	wymiar	cena netto	pak
0401.623	zawór GOSHE 20-43 st KV2,5	863,63	1

Zawór termostacyjny mieszający 1" (G) GRUPA C



Indeks	wymiar	cena netto	pak
0400.935	kvs 2,5 temp. 20-45 °C	137,58	1
0400.936	kvs 3,8 temp. 23-43°C	206,40	1

SŁOWNIK DO ROZDZIELACZA (G) GRUPA C



Indeks	wymiar	cena netto	pak
0331.130	M30 x 1,5	42,85	1

KPL. ŚRUBUNKÓW DO POMPY (MOSIĄDZ) GRUPA H



Indeks	wymiar	cena netto	pak
704.001	3/4"	34,10	1
704.000	1"	50,76	1
704.002	1 1/4"	60,23	1

KPL. ŚRUBUNKÓW DO POMPY (ŻELIWNE CZARNE) GRUPA A



Indeks	wymiar	cena netto	pak
0400.001	1"	24,60	50
0300.999	1 1/4"	26,00	40

KPL. ŚRUBUNKÓW DO POMPY STALOWE GRUPA A



Indeks	wymiar	cena netto	pak
400.001	1"	12,30	1

Akcesoria do rozdzielaczy

AKCESORIA DO ROZDZIELACZY GRUPA B



Indeks	wymiar	cena netto	pak
331.114	korek	5,94	1
331.113	nypel 1/2"/x3/4"	4,54	1

TRÓJNIK DO ROZDZIELACZA GRUPA B



Indeks	wymiar	cena netto	pak
607.190	1/2"x1"x1/2"	13,74	1

ROTAMETR - WSKAŹNIK PRZEPŁYWU Z NYPLEM (G) GRUPA B



Indeks	wymiar	cena netto	pak
0330.592	1/2" SS	23,30	1
0330.593	1/2" mosiądz	23,30	1

Wkładka termostyczna do rozdzielacza kpl. GRUPA B



Indeks	wymiar	cena netto	pak
0330.580	3/4" mosiądz	21,08	1

Wkładka termostyczna do rozdzielacza (bez nypla i pokrętła) GRUPA B



Indeks	wymiar	cena netto	pak
0330.586	3/4"	9,36	1

MODUŁY MIESZAJĄCE z pompą GFT:

• Xtreme

• Xcompaq

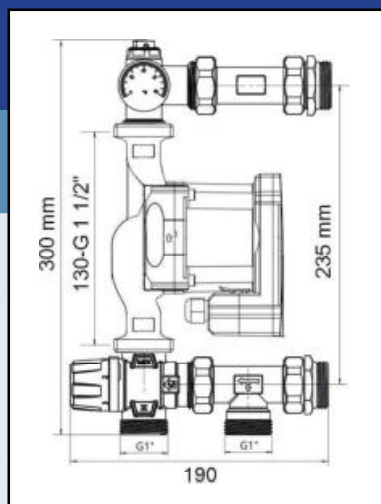

Xtreme

Pompa dwuzakresowa:
podnoszenie 4 m lub 6 m



Xcompaq

Kompaktowa budowa
umożliwiająca montaż
w każdej instalacji

Moduł mieszający z pompą Xtreme		
indeks	kvs (m ³ /h)	parametry pompy
0401.606	2,5	25-4 6-130
0401.607	3,8	
Moduł mieszający z pompą Xcompaq		
indeks	kvs (m ³ /h)	parametry pompy
0401.604	2,5	25-6-130
0401.605	3,8	

DANE TECHNICZNE:

- przyłącza do instalacji: gwint 1"
- przyłącza do rozdzielacza: gwint 1"
- temperatura pracy: max 90°C
- ciśnienie pracy: max 5 bar
- rozstaw: 235 mm

ELEMENTY MODUŁÓW:

- korpus: miedz
- w zestawie:
 - zawór termostaticzny mieszający Goshe: kvs 2,5 m³/h lub 3,8 m³/h
 - **elektroniczna** pompa GFT Xtreme lub Xcompaq
 - termometr: Ø40, 0-120 °C
 - odpowietrznik ręczny
 - nypły przyłączeniowe, wyposażone w oring uszczelniający z EPDM

ZASTOSOWANIE:

Do tłoczenia wody w instalacji grzewczej. Montaż między źródłem ciepła, a rozdzielaczem ogrzewania podłogowego. Mieszacz przygotowuje czynnik grzewczy o stosownej temperaturze i przekazuje go do poszczególnych obwodów instalacji grzewczej.



ROZDZIELACZ PODŁOGOWY



• ZE STALI NIERDZEWNEJ

ROZDZIELACZ PODŁOGOWY ZE STALI NIERDZEWNEJ					
Indeks	Ilość sekcji	L (mm)	grubość ścianki (mm)	przepływ rotametru (l/min)	pakowanie (m/d)
0331.210	2	130	1,60	0-2,5	1/5
0331.211	3	180			
0331.212	4	230			
0331.213	5	280			
0331.214	6	330			
0331.215	7	380			
0331.216	8	430			
0331.217	9	480			
0331.218	10	530			
0331.219	11	580			
0331.220	12	630			
0331.221	13	680			
0331.222	14	730			
0331.223	15	780			
0331.224	16	830			
					1/4

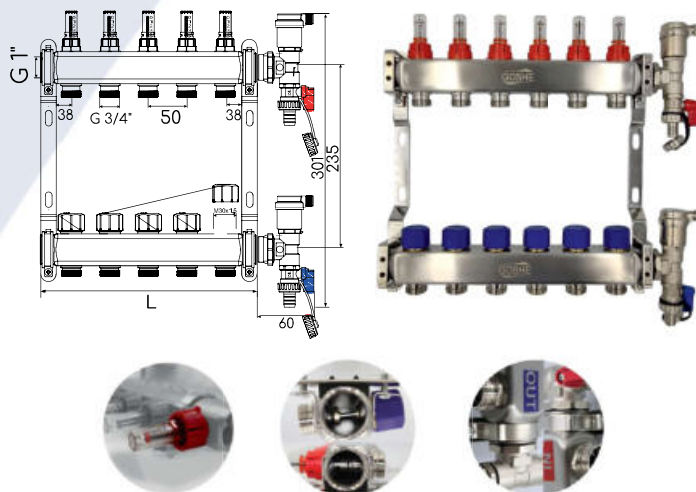

• MOSIĘŻNY

ROZDZIELACZ PODŁOGOWY MOSIĘŻNY				
Indeks	Ilość sekcji	L (mm)	przepływ rotametru (l/min)	pakowanie (m/d)
0330.562	2	100	0-2,5	1
0330.563	3	150		
0330.564	4	200		
0330.565	5	250		
0330.566	6	300		
0330.567	7	350		
0330.568	8	400		
0330.569	9	450		
0330.570	10	500		
0330.571	11	550		
0330.572	12	600		
0330.573	13	650		
0330.574	14	730		
0330.575	15	750		
0330.576	16	800		

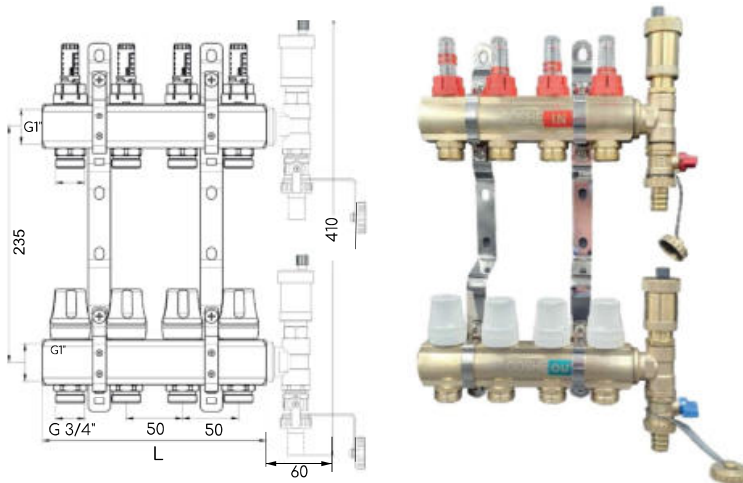

DANE TECHNICZNE

- maks. ciśnienie pracy 6 bar
- maks. temp. pracy 70°C
- media robocze: woda,
- materiał:
 - belka: stal nierdzewna AISI 304 lub mosiądz
 - nypły, trójnik - mosiądz cw617
- wyposażone w gumowe tłumiki drgań
- przyłącza rozdzielacza: G 1"
- przyłącza nypła: G 3/4"

SKŁAD ZESTAWU KOMPLETNEGO

- dwie belki stalowe lub mosiężne
- dwa uchwyty
- dwa zestawy odpowietrzająco-spustowe
- rotametry (przepływ 2,5 l/minutę)
- zawory termostatyczne lub wkładki termostatyczne

ZALETY

- równomierny rozkład temperatury w ogrzewanym pomieszczeniu
- oszczędność energii

ZASTOSOWANIE

- do rozdzielania czynnika grzewczego na poszczególne sekcje w instalacji ogrzewania podłogowego

Rozdzielacz do C.O.



ROZDZIELACZ Z WKŁADKAMI MANUALNYMI MM - KOMPLET (GOSHE)				GRUPA B
* x	Indeks	wymiar	cena netto	pak
**	0331.290	2-obwodowy	255,40	1

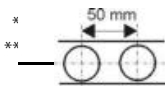

rozstaw
235 mm



ROZDZIELACZ PODŁOGOWY - KOMPLET (MOSIĄDZ) (GOSHE)				GRUPA B
Indeks	wymiar	cena netto	pak	
0330.562	2-obwodowy	291,16	1	
0330.563	3-obwodowy	377,54	1	
0330.564	4-obwodowy	458,68	1	
0330.565	5-obwodowy	539,30	1	
0330.566	6-obwodowy	619,92	1	
0330.567	7-obwodowy	700,54	1	
0330.568	8-obwodowy	781,06	1	
0330.569	9-obwodowy	861,68	1	
0330.570	10-obwodowy	942,30	1	
0330.571	11-obwodowy	1 022,82	1	
0330.572	12-obwodowy	1 103,48	1	
0330.573	13-obwodowy	1 107,69	1	
0330.574	14-obwodowy	1 182,24	1	
0330.575	15-obwodowy	1 258,94	1	
0330.576	16-obwodowy	1 387,00	1	

rozstaw
235 mm

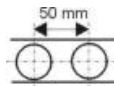

ROZDZIELACZ PODŁOGOWY - KOMPLET (CHROM) (GOSHE)				GRUPA B
Indeks	wymiar	cena netto	pak	
0330.500	2-obwodowy	274,64	1	
0330.501	3-obwodowy	356,64	1	
0330.509	11-obwodowy	964,76	1	

rozstaw
235 mm

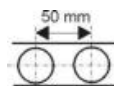

ROZDZIELACZ PODŁOGOWY - KOMPLET (STALOWY) (G)**				GRUPA B
Indeks	wymiar	cena netto	pak	
0331.210	2-obwodowy	224,20	1	
0331.211	3-obwodowy	286,20	1	
0331.212	4-obwodowy	348,70	1	
0331.213	5-obwodowy	410,80	1	
0331.214	6-obwodowy	473,10	1	
0331.215	7-obwodowy	535,80	1	
0331.216	8-obwodowy	597,90	1	
0331.217	9-obwodowy	660,40	1	
0331.218	10-obwodowy	722,60	1	
0331.219	11-obwodowy	785,10	1	
0331.220	12-obwodowy	850,50	1	
0331.221	13-obwodowy	905,80	1	
0331.222	14-obwodowy	962,50	1	
0331.223	15-obwodowy	1019,10	1	
0331.224	16-obwodowy	1075,70	1	

rozstaw
235 mm

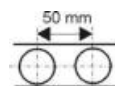



Armatura gazowa

PRZYŁĄCZE ELASTYCZNE DO GAZU WW GRUPA B3

Indeks	wymiar	cena netto	pak
0410.510	L-500	45,38	1/25
0410.511	L-750	58,66	1/25
0410.512	L-1000	62,14	1/25
0410.513	L-1250	72,38	1/20
0410.514	L-1500	80,34	1/20
0410.515	L-2000	99,90	1/20

PRZYŁĄCZE ELASTYCZNE DO GAZU WZ GRUPA B3

Indeks	wymiar	cena netto	pak
0410.530	L-500	45,38	1/25
0410.531	L-750	58,66	1/25
0410.532	L-1000	62,14	1/25
0410.533	L-1250	72,38	1/20
0410.534	L-1500	80,34	1/20
0410.535	L-2000	99,90	1/20

PRZYŁĄCZE ELASTYCZNE DO GAZU Z KOLANEM GRUPA B3

Indeks	wymiar	cena netto	pak
0410.550	L-500	65,32	1/25
0410.551	L-750	79,10	1/25
0410.552	L-1000	96,56	1/25
0410.553	L-1250	105,14	1/20
0410.554	L-1500	116,70	1/20
0410.555	L-2000	141,88	1/20

ZAWÓR GAZOWY GRUPA B

Indeks	wymiar	cena netto	pak
0408.401	1/2"	20,52	20/120
0408.402	3/4"	30,36	20/80
0408.403	1"	46,38	12/48
0408.404	1 1/4"	77,62	4/24
0408.405	1 1/2"	103,36	4/24
0408.406	2"	176,70	2/16

ZAWÓR GAZOWY WZ GRUPA B

Indeks	wymiar	cena netto	pak
0408.451	1/2"	21,50	20/120
0408.452	3/4"	31,58	20/80
0408.453	1"	48,88	12/48

Obejmy

OBEJMA DO RUR BEZ USZCZELKI – POJEDYNCZA GRUPA D1

Indeks	wymiar	cena netto	pak
0780.810	3/8"	2,14	100
0780.811	1/2"	2,22	100
0780.812	3/4"	2,26	100
0780.813	1"	2,40	100
0780.814	1 1/4"	2,88	100
0780.815	1 1/2"	2,94	100
0780.816	2"	3,30	100
0780.817	2 1/2"	3,82	50
0780.818	3"	4,06	50
0780.819	4"	5,96	50
0780.820	5"	7,46	50
0780.821	6"	8,24	50

OBEJMA DO RUR Z USZCZELKĄ – POJEDYNCZA1 GRUPA D1

Indeks	wymiar	cena netto	pak
0780.830	3/8"	2,54	100
0780.831	1/2"	2,64	100
0780.832	3/4"	2,80	100
0780.833	1"	3,30	100
0780.834	1 1/4"	3,70	100
0780.835	1 1/2"	3,92	100
0780.836	2"	4,32	100
0780.837	2 1/2"	5,34	50
0780.838	3"	5,82	50
0780.839	4"	8,20	50
0780.840	5"	10,24	50
0780.841	6"	11,34	50
0780.842	8"	18,04	30

OBEJMA DO RUR BEZ USZCZELKI – PODWÓJNA GRUPA D1

Indeks	wymiar	cena netto	pak
0780.860	3/8"	2,98	100
0780.861	1/2"	2,98	100
0780.862	3/4"	3,06	100
0780.863	1"	3,62	50

OBEJMA DO RUR Z USZCZELKĄ – PODWÓJNA GRUPA D1

Indeks	wymiar	cena netto	pak
0780.880	3/8"	3,48	100
0780.881	1/2"	3,82	100
0780.882	3/4"	4,16	100
0780.883	1"	4,52	50



Złączki chromowane mosiężne

PN 10

REDUKCJA CHROMOWANA

GRUPA B



Indeks	wymiar	cena netto	pak
0470.001	1/2"×3/8"	2,18	10/1200
0470.002	3/4"×1/2"	3,26	10/80

KOLANKO CHROMOWANE

GRUPA B



Indeks	wymiar	cena netto	pak
0470.020	3/8" ww	5,06	10/500
0470.021	1/2" ww	7,78	10/300
0470.022	3/4" ww	13,92	20

KOLANKO CHROMOWANE NYPLOWE

GRUPA B



Indeks	wymiar	cena netto	pak
0470.026	3/8"	5,70	10/500
0470.027	1/2"	8,04	10/300
0470.028	3/4"	13,56	10/200

TRÓJNIK CHROMOWANY WW

GRUPA B



Indeks	wymiar	cena netto	pak
0470.090	3/8"	6,24	10/400
0470.091	1/2"	10,92	10/200
0470.092	3/4"	13,50	15/150

PRZEDŁUŻKA CHROMOWANA

GRUPA B



Indeks	wymiar	cena netto	pak
0470.066	1/2"×10 mm	4,08	80/800
0470.067	1/2"×15 mm	4,78	70/700
0470.068	1/2"×20 mm	5,10	60/600
0470.069	1/2"×25 mm	5,76	40/400
0470.070	1/2"×30 mm	6,46	40/400
0470.072	1/2"×40 mm	7,96	30/300
0470.074	1/2"×50 mm	9,76	25/250
0470.078	3/4"×10 mm	5,28	50
0470.080	3/4"×20 mm	7,96	10/400
0470.082	3/4"×30 mm	9,74	10/200
0470.083	3/4"×40 mm	11,82	10/200

REDUKCJA MUFA-NYPEL (PRZEDŁUŻKA REDUKCYJNA CHROM)

GRUPA B



Indeks	wymiar	cena netto	pak
0470.011	1/2"×3/8"	4,70	10/500
0470.012	3/4"×1/2"	4,78	10/300

NYPEL CHROMOWANY

GRUPA B



Indeks	wymiar	cena netto	pak
0470.054	3/8"	2,52	10/1000
0470.055	1/2"	4,58	10/600
0470.056	3/4"	9,32	10/400

NYPEL REDUKCYJNY CHROMOWANY

GRUPA B



Indeks	wymiar	cena netto	pak
0470.060	1/2"×3/8"	3,56	10/100
0470.062	3/4"×1/2"	4,44	10/500

TRÓJNIK CHROMOWANY ZWW

GRUPA B



Indeks	wymiar	cena netto	pak
0470.096	chrom 1/2"	10,14	10/200

MUFA CHROMOWANA

GRUPA B



Indeks	wymiar	cena netto	pak
0470.045	1/2"	5,00	10/600
0470.046	3/4"	7,32	10/400

MUFA REDUKCYJNA CHROMOWANA

GRUPA B



Indeks	wymiar	cena netto	pak
0470.049	3/8"×1/2"	5,04	10/600
0470.050	1/2"×3/4"	7,56	10/400

ZAŚLEPKA CHROMOWANA

GRUPA B



Indeks	wymiar	cena netto	pak
0470.037	3/8"	1,82	10
0470.038	1/2"	2,96	10
0470.039	3/4"	4,78	10

KOREK CHROMOWANY

GRUPA B



Indeks	wymiar	cena netto	pak
0470.032	3/8"	1,62	10
0470.033	1/2"	3,04	10
0470.034	3/4"	4,36	10



Złączka skręcana do rur wielowarstwowych

Gwarancja 10 lat

ZŁĄCZKA NYFLOWA GRUPA E



Indeks	wymiar	cena netto	pak
0200.490	16×1/2"	9,96	10/300
0200.491	16×3/4"	14,18	4/200
0200.492	20×1/2"	17,24	4/160
0200.493	20×3/4"	17,58	4/160
0200.494	25×1"	27,50	2/100
0200.495	25×3/4"	26,78	5/112
0200.498	32×1"	35,82	5/64

ZŁĄCZKA MUFOWA GRUPA E



Indeks	wymiar	cena netto	pak
0200.500	16×1/2"	11,36	10/250
0200.501	16×3/4"	15,20	10/200
0200.502	20×1/2"	17,44	4/200
0200.503	20×3/4"	19,90	4/184
0200.504	25×1"	26,96	2/112
0200.505	25×3/4"	27,66	2/152
0200.507	32×1"	37,02	2/104

KOLANKO NYFLOWE GRUPA E



Indeks	wymiar	cena netto	pak
0200.522	16×1/2"	14,78	10/200
0200.523	20×1/2"	20,80	10/160
0200.524	20×3/4"	22,12	4/160
0200.525	25×1"	38,86	10/80

KOLANKO MUFOWE GRUPA E



Indeks	wymiar	cena netto	pak
0200.532	16×1/2"	17,02	10/160
0200.533	20×1/2"	22,12	4/132
0200.534	20×3/4"	25,32	4/160
0200.535	25×1"	38,68	2/80

ZŁĄCZKA PODWÓJNA GRUPA E



Indeks	wymiar	cena netto	pak
0200.510	16×16	17,36	10/200
0200.511	20×20	27,64	4/128
0200.512	20×16	22,94	4/280
0200.513	25×25"	43,44	2/80
0200.514	25×20	40,34	5/120

KOLANKO PODWÓJNE GRUPA E



Indeks	wymiar	cena netto	pak
0200.539	16×16	18,58	10/200
0200.540	20×20	28,12	4/176
0200.541	25×25	42,24	5/88

TRÓJNIK NYFLOWY GRUPA E



Indeks	wymiar	cena netto	pak
0200.546	16×1/2"	24,08	10/120
0200.547	20×1/2"	32,08	4/80
0200.548	20×3/4"	36,80	2/80

TRÓJNIK MUFOWY GRUPA E



Indeks	wymiar	cena netto	pak
0200.558	16×1/2"	26,44	10/120
0200.559	20×1/2"	33,16	4/96
0200.560	20×3/4"	41,44	10/80

TRÓJNIK GRUPA E



Indeks	wymiar	cena netto	pak
0200.570	16	27,68	10/100
0200.571	20	41,80	4/60
0200.572	20×16×16	35,64	4/144
0200.573	20×16×20	38,64	4/144
0200.574	25	66,56	2/64
0200.575	25×20×25	58,56	2/80

KOLANKO Z ŁAPKAMI GRUPA E



Indeks	wymiar	cena netto	pak
0200.542	16×1/2"	19,62	10/120
0200.543	20×1/2"	27,12	5/100



Złączka zaprasowywana do rur wielowarstwowych

Gwarancja 10 lat

KOLANKO ZAPRASOWYWANE NYPLOWE GRUPA E



Indeks	wymiar	cena netto	pak
0200.737	32×1"	51,29	5/160

TRÓJNIK ZAPRASOWYWANY NYPLOWY GRUPA E



Indeks	wymiar	cena netto	pak
0200.771	20×1/2"	28,97	4/120
0200.774	25×1/2"	40,73	5/100
0200.775	25×3/4"	44,97	10/100
0200.777	32×1"	64,13	10/100

KOLANKO ZAPRASOWYWANE MUFOWE GRUPA E



Indeks	wymiar	cena netto	pak
0200.744	25×1"	47,08	5/120
0200.747	32×1"	51,29	5/120

TRÓJNIK ZAPRASOWYWANY MUFOWY GRUPA E



Indeks	wymiar	cena netto	pak
0200.787	32×1"	66,69	10/90

Narzędzia montażowe

REMS

ZACISKARKA RĘCZNA EKO-PRESS GRUPA H



Indeks	typ	cena netto
280.032	ręczna (574000)	815,80

ZACISKARKA POWER-PRESS BASIC-PACK GRUPA H



Indeks	typ	cena netto
280.035	sieciowa (577013 R220)	5340,00

ZACISKARKA POWER-PRESS SE GRUPA H



Indeks	typ	cena netto
280.040	sieciowa (572111)	3839,90

ZACISKARKA AKKU-PRESS LI-ION GRUPA H



Indeks	typ	cena netto
280.041	akumulatorowa (571020)	6682,00

CĘGI ZACISKOWE GRUPA H



Indeks	typ U	cena netto
280.031	16 (570765)	668,40
280.0311	20 (570775)	668,40
280.0312	25 (570780)	668,40
280.0313	32 (570785)	668,40



Złączka zaprasowywana do rur wielowarstwowych

GOSHE Gwarancja 10 lat

ZACISK TYP U/TH

ZŁĄCZKA ZAPRASOWYWANA NYPLOWA GRUPA E

Indeks	wymiar	cena netto	pak
0205.700	16×1/2"	14,84	10/250
0205.701	20×1/2"	17,30	4/200
0205.702	20×3/4"	21,56	4/160
0205.703	25×1"	35,29	2/110
0205.704	25×3/4"	28,34	2/160
0205.705	16×3/4"	20,30	10/280
0205.707	32×1"	39,26	5/65

KOLANKO ZAPRASOWYWANE NYPLOWE GRUPA E

Indeks	wymiar	cena netto	pak
0205.730	16×1/2"	21,14	10/240
0205.731	20×1/2"	27,04	4/160
0205.733	20×3/4"	31,24	4/160
0205.734	25×1"	51,34	2/80
0202.735	25×3/4"	34,14	2/100

ZŁĄCZKA ZAPRASOWYWANA PODWÓJNA GRUPA E

Indeks	wymiar	cena netto	pak
0205.720	16	15,64	10/200
0205.721	16×20	19,02	4/160
0205.722	16×25	27,26	8/160
0205.723	20	21,80	4/140
0205.724	25	31,36	2/80
0205.725	20×25	29,00	2/110

TRÓJNIK ZAPRASOWYWANY MUFOWY GRUPA E

Indeks	wymiar	cena netto	pak
0205.780	16×1/2"	31,04	4/120
0202.781	20×1/2"	40,30	4/120
0205.785	25×1/2"	45,20	2/54
0202.785	25×3/4"	58,10	2/54

TRÓJNIK ZAPRASOWYWANY GRUPA E

Indeks	wymiar	cena netto	pak
0205.790	16	27,50	10/130
0205.791	20	40,24	4/80
0205.792	25	58,62	2/48
0202.789	32	86,68	5/40
0202.793	16×20×16	35,96	10/100
0205.794	20×16×16	35,26	4/100
0205.795	20×16×20	37,56	4/84
0205.796	20×20×16	34,04	10/160
0205.797	25×20×20	50,65	2/80
0205.798	25×16×25	53,08	2/80
0202.799	25×20×25	60,26	2/80

LISTWA MONTAŻOWA (PEX) GRUPA D

Indeks	wymiar	cena netto	pak
0603.896	1/2"×16"×150	55,64	1
0603.895	1/2"×16"×100	55,64	1

ZŁĄCZKA ZAPRASOWYWANA MUFOWA GRUPA E

Indeks	wymiar	cena netto	pak
0205.710	16×1/2"	16,50	10/200
0205.711	20×1/2"	19,47	4/280
0205.712	20×3/4"	21,08	4/240
0205.713	25×1"	35,44	2/110
0205.714	25×3/4"	26,08	2/120
0205.715	16×3/4"	17,78	2/110
0205.717	32×1"	38,00	5/65

KOLANKO ZAPRASOWYWANE MUFOWE GRUPA E

Indeks	wymiar	cena netto	pak
0205.740	16×1/2"	21,38	10/150
0205.741	20×1/2"	26,96	4/200
0205.742	20×3/4"	30,40	4/160
0202.743	25×3/4"	33,76	2/90

KOLANKO ZAPRASOWYWANE PODWÓJNE GRUPA E

Indeks	wymiar	cena netto	pak
0205.750	16×16	20,76	10/150
0205.751	20×20	29,64	4/200
0205.752	25×25	41,68	2/64
0205.753	32×32	65,18	2/40

KOLANKO ZAPRASOWYWANE Z ŁĄPKAMI GRUPA E

Indeks	wymiar	cena netto	pak
0205.760	16×1/2"	28,30	10/100
0205.761	20×1/2"	31,70	4/100

KOLANKO ZAPRASOWYWANE PODWÓJNE Z ŁĄPKAMI GRUPA E

Indeks	wymiar	cena netto	pak
0205.765	16×16X1/2"	39,48	4/100

TULEJA GRUPA E

Indeks	wymiar	cena netto	pak
0205.802	16	1,76	/200
0205.803	20	1,98	/100
0205.804	25	3,90	/300
0205.805	32	4,64	/300



Akcesoria do rur WIELOWARSTWOWYCH

Rura, akcesoria PEX-al-PEX

RURA PERT-AL-PERT - LASEROWA GRUPA H

Indeks	wymiar	cena netto	pak
0205.460	16*2,0	4,14	100 m
0205.461	16*2,0	4,14	200 m
0205.462	16*2,0	4,14	500 m
0205.463	20*2,0	7,14	100 m
0205.464	25*2,5	11,49	50 m
0205.465	32*3,0	18,21	50 m

RURA PERT-AL-PERT GRUPA H

Indeks	wymiar	cena netto	pak
0200.485	16*2,0	3,94	100 m
0200.486	16*2,0	3,94	200 m
0200.487	20*2,0	6,80	100 m
0200.488	25*2,5	10,94	50 m
0200.489	32*3,0	17,34	50 m

NOŻYCE DO RURY PEX-AL-PEX GRUPA D

Indeks	wymiar	cena netto	pak
0200.436	szare	21,14	1
0200.439	czerwone S05 >max 42<	53,56	
0200.438	żółte E07 >max 42<	53,56	
0200.440	niebieskie S01 >max 42<	40,84	

ZŁĄCZKA ZACISKOWA DO RUR MIEDZIANYCH GRUPA E

Indeks	wymiar	cena netto	pak
0200.284	15	12,28	40/400

ZŁĄCZKA ZACISKOWA DO RUR PEX-AL-PEX GRUPA E

Indeks	wymiar	cena netto	pak
0200.285	16	11,06	50/500

ZŁĄCZKA ZACISKOWA DO RUR PEX-AL-PEX (EUROKONUS) GRUPA D

Indeks	wymiar	cena netto	pak
0200.281	16x3/4	8,50	50/500

KALIBROWNIK - METALOWY W OBUDOWIE PLASTIKOWEJ GRUPA D

Indeks	wymiar	cena netto	pak
0200.444	16/20/25	309,24	1/100

ZŁĄCZKA ZACISKOWA DO RUR MIEDZIANYCH GRUPA D

Indeks	wymiar	cena netto	pak
0200.280	15	12,28	10/400

KALIBROWNIK - PLASTIK GRUPA D

Indeks	wymiar	cena netto	pak
0200.449	16/20/25	15,44	1

SPRĘŻYNY DO RURY PEX-AL-PEX ZEWNĘTRZNA GRUPA D

Indeks	wymiar	cena netto	pak
0200.454	16	38,02	1
0200.456	20	48,91	1
0200.4561	25	52,81	1
0200.4562	32	57,34	1

KALIBROWNIK - METAL GRUPA D

Indeks	wymiar	cena netto	pak
0200.447	16	52,72	1
0200.448	20	54,56	1
0200.446	25	56,42	1
0200.445	32	57,46	1

SPRĘŻYNY DO RURY PEX-AL-PEX WEWNĘTRZNA GRUPA D

Indeks	wymiar	cena netto	pak
0200.453	16	17,44	1
0200.455	20	22,33	1
0200.4551	25	24,16	1
0200.4552	32	27,16	1

Akcesoria do rur WIELOWARSTWOWYCH



Złączki mosiężne wzmocnione

PRODUKT POLSKI  PN 10

REDUKCJA MUFA-NYPEL MOS. (PRZEDŁUŻKA REDUKCYJNA) GRUPA B



Indeks	wymiar	cena netto	pak
607.450	1/2"×3/8"	3,20	50/500
607.451	3/4"×1/2"	5,25	25/300
607.452	1"×1/2"	7,11	25/300
607.453	1"×3/4"	7,30	25/300
607.454	1/2"×1/4"	3,24	
607.455	1 1/4"×1"	17,86	25/300
607.456	1 1/2"×1"	19,03	10

REDUKCJA MOSIĘŻNA GRUPA B



Indeks	wymiar	cena netto	pak
607.400	3/8"×1/4"	1,92	10/600
607.401	1/2"×1/4"	3,60	10/500
607.402	1/2"- M20 ×1,5w	5,04	10
607.420	1/2"- M12 ×1,5w	3,64	10
607.421	3/4"×3/8"	5,70	10
607.403	1/2"×3/8"	2,38	25/500
607.404	3/4"×1/2"	3,76	25/500
607.405	1"×1/2"	6,84	25/300
607.406	1"×3/4"	5,90	25/250
607.407	1 1/4"×1/2"	14,68	200
607.408	1 1/4"×3/4"	12,40	200
607.409	1 1/4"×1"	9,85	200
607.410	1 1/2"×1/2"	26,02	100
607.411	1 1/2"×3/4"	24,68	100
607.412	1 1/2"×1"	21,84	100
607.413	1 1/2"×1 1/4"	15,26	100
607.414	2"×1/2"	34,06	10
607.415	2"×3/4"	32,40	10
607.416	2"×1"	31,36	10
607.417	2"×1 1/4"	25,68	10
607.418	2"×1 1/2"	18,12	10
607.419	2 1/2"×2"	38,28	10
607.422	2 1/2"×1 1/2"	59,30	10
607.423	3"×2 1/2"	106,50	1

PRZEDŁUŻKA MOSIĘŻNA

GRUPA B



Indeks	wymiar	cena netto	pak
607.320 MAX	1/2"×10 mm	3,44	50/500
607.321 MAX	1/2"×15 mm	4,70	50/400
607.322 MAX	1/2"×20 mm	6,06	25/300
607.323 MAX	1/2"×25 mm	7,28	25/250
607.324 MAX	1/2"×30 mm	7,80	50/200
607.325 MAX	1/2"×40 mm	9,58	25/200
607.326 MAX	1/2"×50 mm	11,30	25/150
607.340	3/8"×10 mm	3,52	10
607.341	3/8"×15 mm	4,90	10
607.342	3/8"×20 mm	5,68	10
607.343	3/8"×30 mm	7,20	10
607.344	3/8"×40 mm	10,36	10
607.345	3/8"×50 mm	10,74	10
607.346	3/8"×60 mm	11,36	10
607.300	1/2"×10 mm	2,66	50/500
607.301	1/2"×15 mm	3,34	50/500
607.302	1/2"×20 mm	4,44	50/400
607.303	1/2"×25 mm	4,84	50/250
607.304	1/2"×30 mm	5,26	50/300
607.305	1/2"×40 mm	6,62	25/200
607.306	1/2"×50 mm	8,46	25/200
607.307	1/2"×60 mm	10,16	10/150
607.308	1/2"×70 mm	11,28	10/150
607.350	3/4"×10 mm	5,08	50/400
607.351	3/4"×15 mm	6,36	50/300
607.352	3/4"×20 mm	7,58	25/250
607.353	3/4"×25 mm	7,72	10/250
607.354	3/4"×30 mm	8,90	10/250
607.355	3/4"×40 mm	10,72	10/150
607.356	3/4"×50 mm	12,28	10/100
607.370	1"×10 mm	6,08	25/250
607.371	1"×15 mm	7,70	25/250
607.372	1"×20 mm	9,24	10/200
607.373	1"×25 mm	10,16	25/150
607.374	1"×30 mm	12,48	10/150
607.375	1"×40 mm	14,24	10/100
607.376	1"×50 mm	16,80	10/100

ZASŁEPKA MOSIĘŻNA GRUPA B



Indeks	wymiar	cena netto	pak
607.120	3/8"	1,68	10/600
607.121	1/2"	2,52	25/500
607.122	3/4"	4,26	10/400
607.123	1"	6,78	10/300
607.124	1 1/4"	8,40	10/300
607.125	1 1/2"	13,08	10
607.126	2"	15,40	10

MUFA MOSIĘŻNA GRUPA B



Indeks	wymiar	cena netto	pak
607.250	1/4"	3,52	10/500
607.251	3/8"	3,48	10/400
607.252	1/2"	5,46	10/400
607.253	3/4"	6,94	10/200
607.254	1"	9,40	10/100
607.255	1 1/4"	18,20	10/80
607.256	1 1/2"	24,96	10/60
607.257	2"	44,38	40

KOREK MOSIĘŻNY GRUPA B



Indeks	wymiar	cena netto	pak
607.100	1/4"	3,02	50
607.101	3/8"	2,18	10/600
607.102	1/2"	2,58	25/500
607.103	3/4"	4,00	10/400
607.104	1"	6,50	25/300
607.105	1 1/4"	7,56	10
607.106	1 1/2"	12,14	10
607.107	2"	17,66	10

MUFA REDUKCYJNA MOSIĘŻNA GRUPA B



Indeks	wymiar	cena netto	pak
607.270	1/2"×3/8"	3,60	10/400
607.271	3/4"×1/2"	5,84	10/300
607.272	1"×1/2"	7,86	10/250
607.273	1"×3/4"	8,66	10/200
607.274	1 1/4"×1"	16,04	1
607.275	1 1/2"×1"	16,14	1
607.276	1 1/2"×1 1/4"	16,96	1



Kształtki MOSIĘŻNE

NYPEL MOSIĘŻNY

GRUPA B



Indeks	wymiar	cena netto	pak
607.200	1/4"	1,92	50
607.201	3/8"	2,64	10/500
607.202	1/2"	2,70	50/500
607.203	1/2" długi L31	3,62	50/400
607.204	1/2" długi L37	4,52	25/350
607.205	3/4"	4,84	25/300
607.206	3/4" długi L40	7,52	25/300
607.208	1"	7,28	25/200
607.209	1" długi L44	10,12	25/150
607.210	1 1/4"	15,68	25/100
607.211	1 1/2"	20,80	10/70
607.212	2"	35,80	70
607.213*	2 1/2"	49,68	50

NYPEL REDUKCYJNY MOSIĘŻNY

GRUPA B



Indeks	wymiar	cena netto	pak
607.220	3/8"x1/4"	2,00	50
607.221	1/2"x1/4"	3,00	50
607.222	1/2"x3/8"	2,74	10/400
607.223	3/4"x1/2"	5,40	10/300
607.224	1"x1/2"	7,28	25/300
607.225	1"x3/4"	9,08	10/250
607.226	1 1/4"x1"	12,74	250
607.230	1 1/2"x1"	16,60	1
607.233	1 1/2"x1 1/4"	17,02	1
607.234	2"x1 1/4"	34,36	1
607.235	2"x1 1/2"	35,10	1

NYPEL MOSIĘŻNY - SOLARNY

GRUPA B



Indeks	wymiar	cena netto	pak
607.240	1/2"	5,46	25/400
607.241	3/4"	10,94	25/250
607.242	1"	16,40	25/100
607.243	1 1/4"	20,66	1
607.246	1/2x3/4	5,94	1
607.247	1x3/4	9,84	1

KOREK MOSIĘŻNY

GRUPA B



Indeks	wymiar	cena netto	pak
607.110	1/gzx3/4gw"	8,76	10

TRÓJNIK MOSIĘŻNY

GRUPA B



Indeks	wymiar	cena netto	pak
607.170	1/2" ZWW	10,84	10/150
607.171	1/2z x3/8w x1/2w* ZWW	10,84	1
607.172	1/2" WZW	9,54	1
607.173	1/2 WZZ	10,40	1
607.174	1/2" ZWZ	10,62	1

KOLANKO MOSIĘŻNE WW

GRUPA B



Indeks	wymiar	cena netto	pak
607.050	3/8"	4,08	25/200
607.051	1/2"	6,50	10/250
607.052	3/4"	9,62	10/200
607.053	1"	17,22	10/100
607.054	1 1/4"	28,88	5/40
607.055	1 1/2"	38,78	10
607.056	2"	83,70	10
607.057	2 1/2"	298,54	10

KOLANKO MOSIĘŻNE WZ

GRUPA B



Indeks	wymiar	cena netto	pak
607.060	3/8" wz	3,28	25/200
607.061	1/2" wz	6,80	25/300
607.062	3/4" wz	11,06	10/200
607.063	1" wz	16,18	10/100
607.064	1 1/4" wz	25,40	5/40
607.065	1 1/2" wz	34,58	10
607.066	2" wz	77,94	10
607.067	2 1/2" wz	310,46	10

KOLANKO MOSIĘŻNE ZZ

GRUPA B



Indeks	wymiar	cena netto	pak
607.080	1/2"	4,70	10/250
607.081	3/4"	7,80	10/150

KOLANKO MOSIĘŻNE ZŁAPKAMI

GRUPA B



Indeks	wymiar	cena netto	pak
607.070	1/2" ww z łapkami	8,46	25/300

TRÓJNIK MOSIĘŻNY MUFOWY

GRUPA B



Indeks	wymiar	cena netto	pak
607.150	3/8"	6,58	25/200
607.151	1/2"	7,72	10/200
607.152	3/4"	10,62	10/100
607.153	1"	21,96	70
607.154	1 1/4"	34,74	5/30
607.155	1 1/2"	50,52	1
607.156	2"	90,72	1
607.180	3/4x1/2x3/4	13,06	10/100
607.181	1x1/2x1	20,44	10/60
607.182	1x3/4x1	20,78	10/60
607.183	1 1/4x1x1 1/4	40,06	10/60
607.184	1 1/4x1/2x1 1/4	43,64	5/30
607.185	1 1/4x3/4x1 1/4	44,20	5/30

TRÓJNIK MOSIĘŻNY NYPLOWY

GRUPA B



Indeks	wymiar	cena netto	pak
607.160	1/2"	6,64	10/200
607.161	3/4"	10,02	10/150
607.162	1"	19,26	10/150

****Zmiana cen na Kształtki MOSIĘŻNE SIZER od 7.04.2026**

Kształtki MOSIĘŻNE



ŚRUBUNEK PROSTY STOŻKOWY

GRUPA B



Indeks	wymiar	cena netto	pak
607.010	3/8"	6,44	50
607.011	1/2"	7,76	200
607.012	3/4"	12,72	100
607.013	1"	21,32	50
607.014	1 1/4"	36,56	50
607.015	1 1/2"	48,10	40
607.016	2"	118,12	20
607.017	2 1/2"	202,86	1
607.018	3"	408,60	1

ŚRUBUNEK PROSTY Z ORINGIEM

GRUPA B



Indeks	wymiar	cena netto	pak
607.000	3/8"	6,96	50
607.001	1/2"	8,38	200
607.002	3/4"	13,74	100
607.003	1"	23,04	50
607.004	1 1/4"	39,48	50
607.005	1 1/2"	51,96	40
607.006	2"	127,60	20
607.007	2 1/2"	219,10	1
607.008	3"	441,30	1

ŚRUBUNEK KĄTOWY STOŻKOWY

GRUPA B



Indeks	wymiar	cena netto	pak
607.030	1/2"	13,74	10
607.031	3/4"	21,50	10
607.032	1"	35,54	10
607.033	1 1/4"	53,38	10
607.034	1 1/2"	78,28	10

ŚRUBUNEK KĄTOWY Z ORINGIEM

GRUPA B



Indeks	wymiar	cena netto	pak
607.020	1/2"	13,74	100
607.021	3/4"	21,50	50
607.022	1"	35,54	50
607.023	1 1/4"	53,38	25
607.024	1 1/2"	78,28	1

PÓŁŚRUBUNEK DO KOTŁA

GRUPA B



Indeks	wymiar	cena netto	pak
607.460	1/2"x1/2"	11,18	10/100
607.461	3/4"x3/4"	16,78	10/100
607.462	1"x1"	21,00	10/100
607.463	1 1/4"x1 1/4"	36,30	10/100

PÓŁŚRUBUNEK KĄTOWY DO KOTŁA

GRUPA B



Indeks	wymiar	cena netto	pak
607.464	1/2"x1/2"	14,10	10/100
607.465	3/4"x3/4"	17,86	10/100
607.466	1"x1"	30,78	10/100

Złączki mosiężne do lutowania

KOLANKO Z ŁAPKAMI DO LUTOWANIA

GRUPA B



Indeks	wymiar	cena netto	pak
606.044	1/2"x15	6,34	10
606.045	1/2"x18	6,78	10

KOLANKO DO LUTOWANIA

GRUPA B



Indeks	wymiar	cena netto	pak
606.048	1/2"x15	5,68	10

MUFA MOSIĘŻNA DO LUTOWANIA

GRUPA B



Indeks	wymiar	cena netto	pak
606.020	15 x 1/2"	3,14	10/500
606.021	18 x 1/2"	3,24	10/400
606.022	22 x 1/2"	5,34	10/500
606.025	15 x 3/4"	4,16	25/500
606.026	18 x 3/4"	4,68	25/400
606.027	22 x 3/4"	5,04	10/300
606.028	28 x 3/4"	5,86	10/250
606.030	22 x 1"	7,94	10/400
606.031	28 x 1"	8,12	10/200
606.032	35 x 1"	9,36	10/100
606.033	35 x 1 1/4"	18,68	10

NYPEL MOSIĘŻNY DO LUTOWANIA

GRUPA B



Indeks	wymiar	cena netto	pak
606.000	15 x 1/2"	2,42	10/500
606.001	18 x 1/2"	2,82	10/200
606.002	22 x 1/2"	6,26	10/400
606.005	15 x 3/4"	4,52	10/500
606.006	18 x 3/4"	3,60	10/200
606.007	22 x 3/4"	4,30	10/300
606.008	28 x 3/4"	6,86	10/400
606.010	22 x 1"	4,54	10/200
606.011	28 x 1"	5,76	10/200
606.012	35 x 1"	8,66	10
606.013	35 x 1 1/4"	15,32	10

GOSHE

KOŃCÓWKI NA WĄŻ MOSIĘŻNE GW

GRUPA B



Indeks	wymiar	cena netto	pak
0201.670	1/2" x 9	4,26	1
0201.671	1/2" x 10	4,26	1
0201.672	1/2" x 12	4,26	1
0201.673	1/2" x 14	4,26	1

KOŃCÓWKI NA WĄŻ MOSIĘŻNE GZ

GRUPA B



Indeks	wymiar	cena netto	pak
0201.650	1/2" x 9	3,96	1
0201.651	1/2" x 10	3,96	1
0201.652	1/2" x 12	3,96	1
0201.653	1/2" x 14	3,96	1



Złączki żeliwne

KOLANKO REDUKCYJNE WW GRUPA A



G90R

Indeks	wymiar	cena netto	pak
0450.005	3/4"×1/2"	7,28	120/10
0450.006	1"×1/2"	10,24	120/60/10
0450.007	1"×3/4"	15,10	120/60/10
0450.008	1 1/4"×1"	16,44	70/35

KOLANKO REDUKCYJNE WZ GRUPA A



G92R

Indeks	wymiar	cena netto	pak
0450.050	3/4"×1/2"	11,50	100/10
0450.052	1"×3/4"	13,78	100/40/10

KOLANKO WW GRUPA A



G90

Indeks	wymiar	cena netto	pak
0450.021	3/8"	4,62	300/10
0450.022	1/2"	4,16	170/10
0450.023	3/4"	6,08	90/10
0450.024	1"	9,24	100/50/10
0450.025	1 1/4"	15,08	70/35
0450.026	1 1/2"	20,54	50/25
0450.027	2"	27,80	25
0450.028	2 1/2"	48,71	12
0450.029	3"	110,90	

KOLANKO WZ GRUPA A



G92

Indeks	wymiar	cena netto	pak
0450.040	3/8"	5,06	260/10
0450.041	1/2"	4,38	160/10
0450.042	3/4"	6,75	100/10
0450.043	1"	10,02	80/40/10
0450.044	1 1/4"	17,44	50/25
0450.045	1 1/2"	21,38	40/20
0450.046	2"	30,16	20/10
0450.047	2 1/2"	67,28	12/6
0450.048	3"	104,30	10

TRÓJNIK GRUPA A



G130

Indeks	wymiar	cena netto	pak
0450.070	3/8"	5,46	140/10
0450.071	1/2"	4,96	100/10
0450.072	3/4"	7,66	60/10
0450.073	1"	12,04	60/30/10
0450.074	1 1/4"	18,12	36/18
0450.075	1 1/2"	22,94	24/12
0450.076	2"	34,76	24
0450.077	2 1/2"	74,14	8/4
0450.078	3"	94,44	8

TRÓJNIK REDUKCYJNY GRUPA A



G130R

Indeks	wymiar	cena netto	pak
0450.080	3/4"×1/2"	9,06	70/10
0450.081	1"×1/2"	14,64	60/30/10
0450.082	1"×3/4"	14,64	60/30/10
0450.084	1 1/4"×1/2"	22,06	60/30/10
0450.085	1 1/4"×3/4"	22,06	50
0450.086	1 1/4"×1"	22,06	50/25
0450.087	1 1/2"×1/2"	27,80	40/20
0450.088	1 1/2"×3/4"	27,80	40/20
0450.089	1 1/2"×1"	27,80	40/20
0450.090	1 1/2"×1 1/4"	27,80	30/15
0450.091	2"×1/2"	39,38	30
0450.092	2"×3/4"	39,38	24/12
0450.093	2"×1"	39,38	24/12
0450.094	2"×1 1/4"	39,38	24/12
0450.095	2"×1 1/2"	39,38	24/12
0450.096	2 1/2"×2"	81,12	15
0450.097	2 1/2"×1 1/4"	81,12	12
0450.098	2 1/2"×1 1/2"	81,12	12
0450.104	3"×2"	121,54	12

CZWÓRNIK GRUPA A



G180

Indeks	wymiar	cena netto	pak
0450.110	1/2"	13,78	70/10
0450.111	3/4"	19,16	50/10
0450.112	1"	25,94	60/30

ZASŁEPKA GRUPA A



G300

Indeks	wymiar	cena netto	pak
0450.232	1/2"	3,26	300/10
0450.233	3/4"	3,94	250/10
0450.234	1"	5,52	150/10
0450.235	1 1/4"	8,10	150/75
0450.236	1 1/2"	10,70	130/65
0450.237	2"	14,96	70/35

KOREK GRUPA A



G290

Indeks	wymiar	cena netto	pak
0450.221	3/8"	2,82	550/10
0450.222	1/2"	2,82	400/10
0450.223	3/4"	3,50	250/10
0450.224	1"	4,38	200/10
0450.225	1 1/4"	6,98	140/70
0450.226	1 1/2"	8,10	100/50
0450.227	2"	11,60	66/33



MUFA REDUKCYJNA

GRUPA A



G240

Indeks	wymiar	cena netto	pak
0450.122	3/4"x1/2"	5,52	120/10
0450.123	1"x1/2"	7,44	140/70/10
0450.124	1"x3/4"	7,44	140/70/10
0450.125	1 1/4"x1/2"	10,92	120/60
0450.126	1 1/4"x3/4"	10,92	120/60
0450.127	1 1/4"x1"	10,92	100/50
0450.130	1 1/2"x1"	12,94	90/45
0450.131	1 1/2"x1 1/4"	12,94	70/35
0450.134	2"x1"	19,70	50/25
0450.135	2"x1 1/4"	19,70	40/20
0450.136	2"x1 1/2"	19,70	40/20
0450.137	3"x2 1/2"	72,42	20

PRZEDŁUKA MUFA-NYPEL

GRUPA A



G529A

Indeks	wymiar	cena netto	pak
450.391	1/2"	6,98	10/180
450.392	3/4"	8,10	10/130
450.393	1"	11,59	10/160

REDUKCJA

GRUPA A



G241



G241D*

Indeks	wymiar	cena netto	pak
0450.280	1/2"x3/8"	3,50	250/10
0450.281	3/4"x1/2"	4,14	250/10
0450.282	1"x1/2"	5,86	180/10
0450.283	1"x3/4"	5,86	180/10
0450.284	1 1/4"x1/2"	9,24	120/60
0450.285	1 1/4"x3/4"	9,24	140/70
0450.286	1 1/4"x1"	9,24	180/90
0450.287	1 1/2"x1/2"	10,92	90/45
0450.288	1 1/2"x3/4"	10,92	100/50
0450.289	1 1/2"x1"	10,92	110/50
0450.290	1 1/2"x1 1/4"	10,92	150/75
0450.291*	2"x1/2"	15,08	60/30
0450.292*	2"x3/4"	15,08	60/30
0450.293	2"x1"	15,08	56/28
0450.294	2"x1 1/4"	15,08	60/30
0450.295	2"x1 1/2"	15,08	60/30
0450.296	2 1/2"x2"	25,54	48/24
0450.297	3"x2"	37,14	24/12
0450.298	3"x2 1/2"	37,14	32
0450.299	4"x1 1/2"	69,54	12
0450.300	4"x2"	69,54	12
0450.301	4"x2 1/2"	69,54	12
0450.302	4"x3"	69,54	12

MUFA

GRUPA A



G270

Indeks	wymiar	cena netto	pak
0450.200	3/8"	3,80	250/10
0450.201	1/2"	3,50	200/10
0450.202	3/4"	4,40	130/10
0450.203	1"	7,44	120/60/10
0450.204	1 1/4"	10,46	100/50
0450.205	1 1/2"	12,72	70/35
0450.206	2"	19,70	36/18
0450.207	2 1/2"	34,76	
0450.209	3"	50,96	14
0450.208	4"	100,52	8

PRZEDŁUKA REDUKCYJNA MUFA-NYPEL

GRUPA A



G246

Indeks	wymiar	cena netto	pak
0450.330	3/4" x 1/2"	10,24	160
0450.331	1" x 1/2"	14,40	160
0450.332	1" x 3/4"	14,40	140
0450.336	1 1/4" x 1"	20,36	100
0450.337	1 1/2" x 1"	24,30	80
0450.338	1 1/2" x 1 1/4"	24,30	80
0450.339	2" x 1"	34,76	50

NYPEL REDUKCYJNY

GRUPA A



G245

Indeks	wymiar	cena netto	pak
0450.170	1/2"x3/8"	4,62	10/280
0450.172	3/4"x1/2"	5,86	10/160
0450.173	1"x1/2"	8,34	10/120
0450.174	1"x3/4"	8,34	10/70/140
0450.175	1 1/4"x1/2"	13,96	150/10
0450.176	1 1/4"x3/4"	13,96	100
0450.177	1 1/4"x1"	13,96	70
0450.179	1 1/2"x3/4"	17,44	90
0450.180	1 1/2"x1"	17,44	45/90
0450.181	1 1/2"x1 1/4"	17,44	80
0450.183	2"x1"	25,54	50
0450.184	2"x1 1/4"	25,54	50
0450.185	2"x1 1/2"	25,54	50

NYPEL

GRUPA A



G280

Indeks	wymiar	cena netto	pak
0450.211	3/8"	3,60	10/360
0450.212	1/2"	3,50	10/250
0450.213	3/4"	4,62	10/160
0450.214	1"	6,54	10/60/120
0450.215	1 1/4"	9,74	50/100
0450.216	1 1/2"	13,16	40/80
0450.217	2"	18,12	50
0450.218	2 1/2"	30,16	12/24
0450.219	3"	50,96	8/16



Kształtki ŻELIWNE OCYNKOWANE

ŚRUBUNEK PŁASKI

GRUPA A



G330D

Indeks	wymiar	cena netto	pak
0450.250	3/8"	14,54	10/120
0450.251	1/2"	13,74	10/80
0450.252	3/4"	16,88	10/60
0450.253	1"	20,60	10/30/60
0450.254	1 1/4"	29,04	20/40
0450.255	1 1/2"	38,48	15/30
0450.256	2"	55,14	10/20
0450.257	2 1/2"	100,58	10
0450.258	3"	150,64	1

ŚRUBUNEK PŁASKI WZ

GRUPA A



G331D

Indeks	wymiar	cena netto	pak
0450.261	1/2"	16,66	10/80
0450.262	3/4"	21,60	10/60
0450.263	1"	24,96	10/30/60
0450.264	1 1/4"	38,26	20/40
0450.265	1 1/2"	47,66	15/30
0450.266	2"	64,46	10/20

ŚRUBUNEK STOŻKOWY

GRUPA A



G340

Indeks	wymiar	cena netto	pak
0450.381	1/2"	13,74	10/80
0450.382	3/4"	16,31	10/610
0450.383	1"	19,41	10/30/60
0450.384	1 1/4"	29,04	20/40
0450.385	1 1/2"	37,84	80
0450.386	2"	55,14	10/20

KOMPLET ŚRUBUNKW DO POMP ŻELIWNE - CZARNE

GRUPA A



B 353

Indeks	wymiar	cena netto	pak
0400.001	1"	24,60	50
0300.999	1 1/4"	26,00	40



Armatura pomiarowa

MANOMETR 63 MM RADIALNY GRUPA B



przylącze
G 1/4"

Indeks	zakres wskazań	cena netto	pak
0705.306	0-1 bar	14,80	1/100
0705.308	0-1,6 bar	14,80	1/100
0705.310	0-2,5 bar	14,80	1/100
0705.312	0-4 bar	14,80	1/100
0705.316	0-6 bar	14,80	1/100
0705.318	0-10 bar	14,80	1/100
0705.324	0-16 bar	14,80	1/100

MANOMETR 63 MM AXIALNY GRUPA B



przylącze
G 1/4"

Indeks	zakres wskazań	cena netto	pak
0705.305	0-1 bar	15,62	1/100
0705.307	0-1,6 bar	15,62	1/100
0705.309	0-2,5 bar	15,62	1/100
0705.311	0-4 bar	15,62	1/100
0705.315	0-6 bar	15,62	1/100
0705.319	0-10 bar	15,62	1/100
0705.323	0-16 bar	15,62	1/100

MANOMETR 100 MM RADIALNY 20X1,5 GRUPA B



przylącze
M20x1,5

Indeks	zakres wskazań	cena netto	pak
0705.369	0-1,6 bar	32,22	1/50
0705.370	0-1 bar	32,22	1/50
0705.371	0-2,5 bar	32,22	1/50
0705.372	0-4 bar	32,22	1/50
0705.375	0-6 bar	32,22	1/50
0705.376	0-10 bar	32,22	1/50
0705.377	0-16 bar	32,22	1/50

TERMOMANOMETR 80 MM GRUPA B



przylącze
G 1/2"

Indeks	zakres wskazań	cena netto	pak
0705.351	1-4 bar, 0-120°C axialny	36,50	1/60
0705.353	1-6 bar, 0-120°C axialny	36,50	1/60
0705.350	1-4 bar, 0-120°C radialny	36,50	1/60
0705.352	1-6 bar, 0-120°C radialny	36,50	1/60

MANOMETR 50 MM RADIALNY - GOSHE (DO REDUKTORA CIŚNIENIA) GRUPA B



przylącze
G 1/4"

Indeks	zakres wskazań	cena netto	pak
0705.390	0-10 bar	14,04	1/1

TERMOMETR 63 MM GRUPA B



przylącze
G 1/2"

Indeks	zakres wskazań	cena netto	pak
0705.330	Opaskowy 0-120 °C	17,90	1/100

TERMOMETR TB-100 - AXIALNY GRUPA B



przylącze
G 1/2"

Indeks	zakres wskazań	cena netto	pak
0705.340	0-120 °C	31,66	2/50

TERMOMETR 63 MM GRUPA B



przylącze
G 1/2"

Indeks	zakres wskazań	cena netto	pak
0705.332	Radialny 0-120 °C	29,34	2/100

TERMOMETR 63 MM GRUPA B



przylącze
G 1/2"

Indeks	zakres wskazań	cena netto	pak
0705.331	Axialny 0-120 °C	16,18	1/150
0705.333	Axialny L-70 0-120 °C	18,76	1/150

TERMOMETR 40 MM GRUPA B



przylącze
G 1/4"

Indeks	zakres wskazań	cena netto	pak
0705.327	Axialny 0-120 °C	13,70	1/100

REDUKCJA DO MANOMETRU GRUPA B



Indeks	wymiar	cena netto	pak
607.401*	1/2"×1/4"	3,60	10
607.420*	1/2"×M12 x1,5	3,64	10
607.402*	1/2"×M20 x1,5	5,04	10



SERIA INEZ

BATERIA WANNOWA ŚCIENNA Z AKCESORIAMI GRUPA F



Indeks	cena netto	pak
0611.500	209,96	12 szt.

BATERIA UMYWALKOWA STOJĄCA GRUPA F



Indeks	cena netto	pak
0611.501	134,04	12 szt.

BATERIA UMYWALKOWA ŚCIENNA GRUPA F



Indeks	cena netto	pak
0611.502 wyl. 18 cm	167,34	12 szt.

BATERIA NATRYSKOWA Z AKCESORIAMI GRUPA F



Indeks	cena netto	pak
0611.505	169,10	12 szt.

BATERIA ZLEWOZMYWAKOWA STOJĄCA GRUPA F



Indeks	cena netto	pak
0611.506 wyl. 16 cm	118,56	12 szt.
0611.507 wyl. 25 cm	120,00	12 szt.

BATERIA ZLEWOZMYWAKOWA ŚCIENNA GRUPA F



Indeks	cena netto	pak
0611.504 wyl. 25 cm	168,48	12 szt.

BATERIA ZLEWOZMYWAKOWA Z WYSOKĄ WYLEWKĄ GRUPA F



Indeks	cena netto	pak
0611.509	163,38	12 szt.

BATERIA BIDETOWA GRUPA F



Indeks	cena netto	pak
0611.508	143,84	12 szt.

SERIA LIRA

BATERIA WANNOWA ŚCIENNA Z AKCESORIAMI GRUPA F



Indeks	cena netto	pak
0611.520	209,96	12 szt.

BATERIA UMYWALKOWA STOJĄCA GRUPA F



Indeks	cena netto	pak
0611.521	134,04	12 szt.

BATERIA UMYWALKOWA ŚCIENNA GRUPA F



Indeks	cena netto	pak
0611.522 wyl. 18 cm	167,34	12 szt.

BATERIA NATRYSKOWA Z AKCESORIAMI GRUPA F



Indeks	cena netto	pak
0611.525	169,10	12 szt.

BATERIA ZLEWOZMYWAKOWA STOJĄCA GRUPA F



Indeks	cena netto	pak
0611.527 wyl. 25 cm	120,00	12 szt.

BATERIA ZLEWOZMYWAKOWA ŚCIENNA GRUPA F



Indeks	cena netto	pak
0611.523 wyl. 25 cm	168,48	12 szt.

BATERIA ZLEWOZMYWAKOWA Z WYSOKĄ WYLEWKĄ GRUPA F



Indeks	cena netto	pak
0611.529	163,38	12 szt.

BATERIA BIDETOWA GRUPA F



Indeks	cena netto	pak
0611.528	143,84	12 szt.

Baterie KUCHENNE



BATERIE KUCHENNE

BATERIA NURIA

GRUPA F



Indeks	cena netto	pak
0611.684	233,96	1/5

BATERIA LIVIA

GRUPA F



Indeks	cena netto	pak
0611.681 czarna	273,22	1/5

BATERIA TRINI (CZARNY MAT)

GRUPA F



Indeks	cena netto	pak
0611.770	242,98	1/5



0611.673 beż	273,22	1/5
-----------------	--------	-----



beż



antracyt

MILA BATERIA Z ELASTYCZNĄ WYLEWKĄ GRUPA F

Bateria stojąca

cena netto

195,95

pakowanie

1/10



0611.490

czarna



0611.491

beżowa



0611.492

szara



0611.493

ciemno szara



Wymienna wylewka



Głowica ceramiczna



Elastyczna wylewka



Regulacja zasięgu



Obrotowa wylewka

GOSHE

IBBIE

BATERIA Z ELASTYCZNĄ WYLEWKĄ

GRUPA
F

Bateria stojąca

cena
netto

218,90

pakowanie

1/10



0611.685

czerwona



0611.688

niebieska



0611.690

szara



0611.692

beżowa



0611.686

fioletowa



0611.687

pomarańczowa



0611.689

czarna



0611.691

biała



0611.693

grafitowa

Bateria ścienna

cena
netto

276,50

pakowanie

1/10



0611.697

beżowa



0611.698

czarna



0611.699

grafitowa



Wymienna
wylewka



Głowica
ceramiczna



Elastyczna
wylewka



Regulacja
zasięgu



Obrotowa
wylewka

SOLA

BATERIA

łazienkowa



GRUPA

F

wannowa



0611.480



cena netto
197,48

umywalkowa



0611.481



cena netto
144,14

prysznicowa



0611.485



cena netto
171,84

kuchenna
z wysoką wylewką



0611.487



cena netto
155,22



SERIA LETA

BATERIA WANNOWA ŚCIENNA Z AKCESORIAMI GRUPA F



Indeks	cena netto	pak
0611.760	282,68	12 szt.

BATERIA UMYWALKOWA STOJĄCA GRUPA F



Indeks	cena netto	pak
0611.761	177,76	12 szt.

BATERIA UMYWALKOWA ŚCIENNA GRUPA F



Indeks	cena netto	pak
0611.762wyl. L16 cm	203,64	12 szt.

BATERIA NATRYSKOWA Z AKCESORIAMI GRUPA F



Indeks	cena netto	pak
0611.765	237,14	12 szt.

BATERIA ZLEWOZMYWAKOWA ŚCIENNA GRUPA F



Indeks	cena netto	pak
0611.763 wyl. L25 cm	205,46	12 szt.

SERIA GERA

BATERIA WANNOWA ŚCIENNA Z AKCESORIAMI GRUPA F



Indeks	cena netto	pak
0611.740	257,54	12 szt.

BATERIA UMYWALKOWA STOJĄCA GRUPA F



Indeks	cena netto	pak
0611.741	180,54	12 szt.

BATERIA UMYWALKOWA ŚCIENNA GRUPA F



Indeks	cena netto	pak
0611.742 wyl. L16 cm	203,64	12 szt.

BATERIA NATRYSKOWA Z AKCESORIAMI GRUPA F



Indeks	cena netto	pak
0611.745	207,32	12 szt.

BATERIA ZLEWOZMYWAKOWA ŚCIENNA GRUPA F



Indeks	cena netto	pak
0611.743 wyl. L25 cm	216,46	12 szt.

BATERIA KUCHENNA GRUPA F



Indeks	cena netto	pak
0611.749	194,10	12 szt.

BATERIA KUCHENNA GRUPA F



Indeks	cena netto	pak
0611.746	303,94	12 szt.



SERIA MONITA

BATERIA WANNOWA ŚCIENNA Z AKCESORIAMI GRUPA F



Indeks	cena netto	pak
0611.470	236,00	12 szt.

*BATERIA WANNOWA STOJĄCA GRUPA F



Indeks	cena netto	pak
0611.479	268,90	12 szt.

BATERIA UMYWALKOWA STOJĄCA GRUPA F



Indeks	cena netto	pak
0611.471	157,36	12 szt.

BATERIA UMYWALKOWA ŚCIENNA GRUPA F



Indeks	cena netto	pak
0611.473 wyl. L16 cm	176,50	12 szt.

BATERIA PRYSZNICOWA Z AKCESORIAMI GRUPA F



Indeks	cena netto	pak
0611.475	184,34	12 szt.

BATERIA ZLEWOZMYWAKOWA ŚCIENNA GRUPA F



Indeks	cena netto	pak
0611.474 wyl. L25 cm	177,30	12 szt.

BATERIA ZLEWOZMYWAKOWA STOJĄCA GRUPA F



Indeks	cena netto	pak
0611.476 wyl. L16 cm	122,72	12 szt.
0611.477 wyl. L25 cm	123,88	12 szt.
0611.467 wyl. L25 cm antracyt	138,64	12 szt.

BATERIA ZLEWOZMYWAKOWA WYSOKA WYLEWKA GRUPA F



Indeks	cena netto	pak
0611.478 wyl. L25cm	162,04	12 szt.
0611.466 wyl. L25cm antracyt	180,94	12 szt.

BATERIA Z WYCIAGANĄ WYLEWKĄ GRUPA F



Indeks	cena netto	pak
0611.469	250,42	12 szt.

SERIA PERLA

BATERIA WANNOWA ŚCIENNA Z AKCESORIAMI GRUPA F



Indeks	cena netto	pak
0611.450	236,00	12 szt.

*BATERIA WANNOWA STOJĄCA GRUPA F



Indeks	cena netto	pak
0611.459	268,90	12 szt.

BATERIA UMYWALKOWA STOJĄCA GRUPA F



Indeks	cena netto	pak
0611.451	157,36	12 szt.

BATERIA UMYWALKOWA ŚCIENNA GRUPA F



Indeks	cena netto	pak
0611.453 wyl. L16 cm	176,50	12 szt.

BATERIA PRYSZNICOWA Z AKCESORIAMI GRUPA F



Indeks	cena netto	pak
0611.455	184,34	12 szt.

BATERIA ZLEWOZMYWAKOWA ŚCIENNA GRUPA F



Indeks	cena netto	pak
0611.454 wyl. L25 cm	177,30	12 szt.

BATERIA ZLEWOZMYWAKOWA STOJĄCA GRUPA F



Indeks	cena netto	pak
0611.456 wyl. L17cm	122,72	12 szt.
0611.457 wyl. L27cm	123,88	12 szt.

BATERIA ZLEWOZMYWAKOWA STOJĄCA GRUPA F



Indeks	cena netto	pak
0611.458 wyl. L27cm	162,04	12 szt.

BATERIA ZLEWOZMYWAKOWA ŚCIENNA Z PRZEŁĄCZNIKIEM GRUPA F



Indeks	cena netto	pak
0611.452 wyl. L30 cm	266,54	12 szt.



SERIA STANDARD

BATERIA WANNOWA ŚCIENNA Z AKCESORIAMI GRUPA F



Indeks	cena netto	pak
0611.640	273,66	12 szt.

BATERIA WANNOWA ŚCIENNA Z DŁUGĄ WYLEWKĄ GRUPA F



Indeks	cena netto	pak
0611.641	289,70	12 szt.

BATERIA NATRYSKOWA Z AKCESORIAMI GRUPA F



Indeks	cena netto	pak
0611.642	192,18	12 szt.

BATERIA UMYWALKOWA GRUPA F



Indeks	cena netto	pak
0611.643	222,30	12 szt.

BATERIA ZLEWOZMYWAKOWA F GRUPA F



Indeks	cena netto	pak
0611.644	160,48	12 szt.

BATERIA UMYWALKOWA ŚCIENNA GRUPA F



Indeks	cena netto	pak
0611.645 wyl. CL 18 cm	179,86	12 szt.
0611.646 wyl. SL 18 cm	179,86	12 szt.

BATERIA ZLEWOZMYWAKOWA ŚCIENNA GRUPA F



Indeks	cena netto	pak
0611.647 wyl. CL 25 cm	181,42	12 szt.
0611.648 wyl. SL 25 cm	181,42	12 szt.

BATERIA ZLEWOZMYWAKOWA ŚCIENNA F GRUPA F



Indeks	cena netto	pak
0611.649	180,70	12 szt.

BATERIA KRAN GRUPA F



Indeks	cena netto	pak
0611.650 wyl. C	84,54	2/12 szt.
0611.651 wyl. S	84,54	2/12 szt.

SERIA RETRO

BATERIA WANNOWA ŚCIENNA Z AKCESORIAMI GRUPA F



Indeks	cena netto	pak
0611.660	331,10	12 szt.

BATERIA WANNOWA ŚCIENNA Z DŁUGĄ WYLEWKĄ GRUPA F



Indeks	cena netto	pak
0611.661	354,30	12 szt.

BATERIA NATRYSKOWA Z AKCESORIAMI GRUPA F



Indeks	cena netto	pak
0611.662	216,02	12 szt.

BATERIA UMYWALKOWA GRUPA F



Indeks	cena netto	pak
0611.663	233,12	12 szt.

BATERIA ZLEWOZMYWAKOWA F GRUPA F



Indeks	cena netto	pak
0611.664	162,26	12 szt.

BATERIA UMYWALKOWA ŚCIENNA GRUPA F



Indeks	cena netto	pak
0611.665 wyl. CL 18 cm	193,44	12 szt.
0611.666 wyl. SL 18 cm	193,44	12 szt.

BATERIA ZLEWOZMYWAKOWA ŚCIENNA GRUPA F



Indeks	cena netto	pak
0611.667 wyl. CL 25 cm	194,78	12 szt.
0611.668 wyl. SL 25 cm	194,78	12 szt.

BATERIA ZLEWOZMYWAKOWA ŚCIENNA F GRUPA F



Indeks	cena netto	pak
0611.669	193,34	12 szt.



Seria OSLO

BATERIA PODTYNKOWA OSLO 1 GRUPA F



Indeks	wymiar	cena netto	pak
0600.875	OKRĄGŁA	391,09	1

Wylewki, zawieszania

WYLEWKA ŚCIENNA L-400 GRUPA I



Indeks	wymiar	cena netto	pak
0600.831	KWADRATOWA	54,15	1/20

ZAWIESZENIE PUNKTOWE Z PRZYŁĄCZEM GRUPA I



Indeks	wymiar	cena netto	pak
0600.838	KWADRATOWE	42,88	1

Deszczownice

DESZCZOWNICA OSLO (METAL) GRUPA I



Indeks	wymiar	cena netto	pak
0600.816	OKRĄGŁA φ30	108,46	1/10

DESZCZOWNICA (ABS) GRUPA I



Indeks	wymiar	cena netto	pak
0600.092	OKRĄGŁA φ28	69,80	1/10

DESZCZOWNICA OSLO (METAL) GRUPA I



Indeks	wymiar	cena netto	pak
0600.821	kwadrat A30	89,31	1/20

DESZCZOWNICA (ABS) GRUPA I



Indeks	wymiar	cena netto	pak
0600.092	OKRĄGŁA φ28	69,80	1/10

Wężę prysznicowe

WĄŻ PRYSZNICOWY WZMOCNIONY - BLISTER GRUPA I



Indeks	wymiar	cena netto	pak
0600.200	125 cm	21,74	1/40
0600.201	150 cm	22,64	1/50

WĄŻ PRYSZNICOWY (PVC) - L150 GRUPA I



Indeks	wymiar	cena netto	pak
0600.217	transparentny	15,85	1

WĄŻ PRYSZNICOWY WZMOCNIONY GRUPA I



Indeks	wymiar	cena netto	pak
0600.204	L-125	13,87	1/50
0600.205	L-150	15,38	1/50
0600.206	L-175	18,11	1/50
0600.207	L-200	20,98	1/50



0600.218	szary	10,36	1
----------	-------	-------	---



0600.219	biały	7,78	1
----------	-------	------	---

WĄŻ DO BATERII Z WYCIĄGANĄ WYLEWKĄ GRUPA I



Indeks	wymiar	cena netto	pak
0600.211	L 120	24,15	1/100

WĄŻ PRYSZNICOWY ROZCIĄGLIWY GRUPA I





Indeks	wymiar	cena netto	pak
0600.210	L 150	24,60	1





Słuchawki prysznicowe Lima

GRUPA I		
Indeks	cena netto	pak
0600.000	10,26	100



Sofia

GRUPA I		
Indeks	cena netto	pak
0600.001	11,78	100



Quito

GRUPA I		
Indeks	cena netto	pak
0600.023	13,70	100



Retro

GRUPA I		
Indeks	cena netto	pak
0600.022	61,86	45



Dżuba

GRUPA I		
Indeks	cena netto	pak
0600.045	10,20	100



Lusaka

GRUPA I		
Indeks	cena netto	pak
0600.041	14,97	100



Kampala

GRUPA I		
Indeks	cena netto	pak
0600.040	14,30	100

Nikozja



GRUPA I		
Indeks	cena netto	pak
0600.018	21,74	100

do baterii z wyciąganą wylewką



Hawana

GRUPA I		
Indeks	cena netto	pak
0600.004	18,40	1/25

Ankara (czarny MAT)



GRUPA I		
Indeks	cena netto	pak
0600.002	19,70	1/25

CZARNY
MAT



Numea

GRUPA I		
Indeks	cena netto	pak
0600.011	16,45	100



Apia

GRUPA I		
Indeks	cena netto	pak
0600.015	25,64	100

Panama



GRUPA I		
Indeks	cena netto	pak
0600.006	22,17	1/25

BLISTER

Luanda

GRUPA I		
Indeks	cena netto	pak
0600.016	15,40	50

Sana

GRUPA I		
Indeks	cena netto	pak
0600.007	22,17	1/25

BLISTER

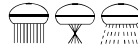
Słuchwki PRYSZNICOWE, KORKI



Valletta

GRUPA I		
Indeks	cena netto	pak
0600.043	16,90	100

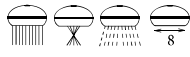

Malabo

GRUPA I		
Indeks	cena netto	pak
0600.047	23,70	100

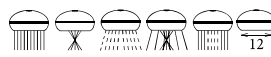
Victoria

GRUPA I		
Indeks	cena netto	pak
0600.009	33,20	1/25





BLISTER

Wężę do pralki

WAŻ DO PRALKI ODPROWADZAJĄCY

GRUPA I				
Indeks	wymiar	cena netto	pak	
0611.260	150 cm	10,02	1	
0611.261	200 cm	12,34	1	
0611.262	250 cm	14,64	1	
0611.263	300 cm	16,96	1	
0611.264	400 cm	25,56	1	



WAŻ DO PRALKI ZASILAJĄCY

GRUPA I				
Indeks	wymiar	cena netto	pak	
0611.250	100 cm	10,20	10	
0611.251	150 cm	12,68	10	
0611.252	200 cm	15,16	10	
0611.253	250 cm	17,78	10	
0611.254	300 cm	20,38	10	
0611.256	400 cm	25,56	10	



Addis

GRUPA I		
Indeks	cena netto	pak
0600.020	27,40	1/25

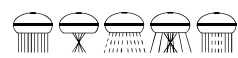
Korki

KOREK KLIK-KLAK (RING MAŁY)

GRUPA I		
Indeks	cena netto	pak
0600.351	33,68	1/100



G 1 1/4" **mosiężny**

KOREK KLIK-KLAK (RING DUŻY)

GRUPA I		
Indeks	cena netto	pak
0600.352	40,94	1/100



G 1 1/4" **mosiężny**

KOREK KLIK-KLAK (RING MAŁY) Z TULEJĄ

GRUPA I		
Indeks	cena netto	pak
0600.354	43,94	1/50



G 1 1/4" **mosiężny**

KOREK AUTOMATYCZNY DO UMYWALKI

GRUPA I		
Indeks	cena netto	pak
0600.350	46,50	1



G 1 1/4" **mosiężny**

KOREK KLIK-KLAK (RING MAŁY)

GRUPA I		
Indeks	cena netto	pak
0600.355	37,06	1/100



bez przelewu **mosiężny**



Perlatory

PERLATOR M28 GZ		GRUPA I	
Indeks	cena netto	pak	
0600.232	4,92	1/250	
M28 GZ			



PERLATOR		GRUPA I	
Indeks	cena netto	pak	
0600.231	3,34	1/500	
M24 GZ			



PERLATOR M22 GW		GRUPA I	
Indeks	cena netto	pak	
0600.230	3,62	1/250	
M22 GW			



PERLATOR		GRUPA I	
Indeks	cena netto	pak	
0600.244	3,98	1/500	
DO BATERII SOLA M20 GZ			



PERLATOR		GRUPA I	
Indeks	cena netto	pak	
0600.225	13,80	00/000	
długi- metalowy giętki			



PERLATOR		GRUPA I	
Indeks	cena netto	pak	
0600.227	18,02	50/250	
długi- metalowy „memo” pamięć kształtu			



PERLATOR		GRUPA I	
Indeks	cena netto	pak	
0600.221	12,10	50/250	
średni			



PERLATOR		GRUPA I	
Indeks	cena netto	pak	
0600.222	10,86	50/250	
długi			



PERLATOR		GRUPA I	
Indeks	cena netto	pak	
0600.220	10,52	100/400	
krótki			



Zawieszania słuchawek Pik

		GRUPA I	
Indeks	cena netto	pak	
0600.300 metal	20,62	1/100	



Joker

		GRUPA I	
Indeks	cena netto	pak	
0600.305	5,28	1/250	
ABS			



Atu

		GRUPA I	
Indeks	cena netto	pak	
0600.306	6,74	1/200	
ABS			



Kier

		GRUPA I	
Indeks	cena netto	pak	
0600.302	6,74	1/250	
ABS			





Syfony i akcesoria do syfonów

SYFON DO PRALKI NADTYNKOWY GRUPA B

Indeks	cena netto	pak
0600.470	7,56	1
biały		
0600.471	12,20	1
chrom		

SYFON ELASTYCZNY DO ZLEWU GRUPA B

Indeks	cena netto	pak
0600.476	5,16	1
DN 32 (DO UMYWALKI)		
0600.477	6,20	1
DN 40 (DO ZLEWU)		

REDUKCJA GUMOWA GRUPA B

Indeks	cena netto	pak
0600.494 25/50 cz.	2,30	1
0600.495 32/50 b.	2,30	1
0600.496 40/50 cz.	2,60	1

Złącza do WC

ZŁĄCZE DO WC GRUPA B

Indeks	cena netto	pak
0600.483	23,24	1/20
350 mm		
0600.484	24,40	1/20
450 mm		
0600.485	25,58	1/20
550 mm		

ZŁĄCZE DO WC GRUPA B

Indeks	cena netto	pak
0600.482	18,62	1
rozciągliwe		

Półsyfony

PÓLSYFON UMYWALKOWY BUTELKOWY GRUPA B

Indeks	cena netto	pak
0600.469	40,41	1
CHROM		

PÓLSYFON UMYWALKOWY RUROWY GRUPA B

Indeks	cena netto	pak
0600.468	39,78	1
CHROM		

Klucz do peratora

KLUCZ DO PERLATORW GRUPA I

Indeks	cena netto	pak
0600.260	4,00	1
(M20, M22, M24, M28)X1		

Akcesoria do baterii

GŁOWICA SUWAKOWA DO BATERII WIELOKLIN 15 GRUPA I1

Indeks	wymiar	cena netto	pak
0611.907	1/2" Ch	8,36	1/250
0611.906	1/2" Dz	8,36	1/250
0611.905	3/8"	7,92	1/300

GŁOWICA CERAMICZNA DO BATERII 1/2" WIELOKLIN 20 GRUPA I1

Indeks	wymiar	cena netto	pak
0611.908*	czerwona	9,38	1/500

* do baterii standard i retro Goshe

KOLANO DO BATERII CHROMOWANE GRUPA I1

Indeks	wymiar	cena netto	pak
0611.930	1/2"x3/4"	40,24	2/40

GŁOWICA DO BATERII GRUPA I

Indeks	wymiar	cena netto	pak
0611.900	DN 35 niska	9,26	1/200
0611.903	DN 35 wysoka	9,74	1/100
0611.901	DN 40 niska	12,54	1/150
0611.904	DN 40 wysoka	12,54	1/100
0611.915	DN 25	12,18	1/100

GŁOWICA DO BATERII (DO BATERII NELIA) GRUPA I

Indeks	wymiar	cena netto	pak
0611.902	DN 40	14,83	1/200

GŁOWICA CERAMICZNA 1/2" DO BATERII WIELOKLIN 15 GRUPA I1

Indeks	wymiar	cena netto	pak
0611.916	czerwona	9,88	1/420
0611.917	niebieska	9,88	1/420



Wylewki do baterii

WYLEWKA DO BATERII – PROSTA GRUPA I

	Indeks	wymiar	cena netto	pak
	0611.401	L-15	25,26	1
	0611.402	L-20	26,98	1
	0611.403	L-25	28,30	1
	0611.404	L-30	31,30	1







WYLEWKA DO BATERII – WYGIĘTA GRUPA I

	Indeks	wymiar	cena netto	pak
	0611.406	L-15	25,26	1
	0611.407	L-20	26,98	1
	0611.408	L-25	28,30	1
	0611.409	L-30	31,30	1

WYLEWKA DO BATERII - WYSOKA GRUPA I

	Indeks	wymiar	cena netto	pak
	0611.410		30,28	1

LISTWA MONTAŻOWA GRUPA H

	Indeks	wymiar	cena netto	pak
	603.892	1/2"x1/2"x100	33,72	50
	603.893	1/2"x1/2"x150	33,72	50
	603.890	15x1/2"x100łut	30,46	50
	603.891	15x1/2"x150łut	30,46	50
	0603.896	16x1/2"x150	55,64	1
	0603.895	16x1/2"x100	55,64	1

Części serwisowe do baterii

PRZEŁĄCZNIK DO DESZCZOWNI GRUPA II

	Indeks	wymiar	cena netto	pak
	0611.944	-	50,18	1

PRZEŁĄCZNIK DO BATERII WANNOWEJ GRUPA II

	Indeks	wymiar	cena netto	pak
	0611.953	35 sprężynka	34,58	1
	0611.954	40 sprężynka	34,58	1

POKRĘTŁO DO BATERII GRUPA I

	Indeks	wymiar	cena netto	pak
	0611.968	CIEPŁA (COLD)	32,04	-
	0611.969	ZIMNE (HOT)	32,04	-

TULEJA MASKUJĄCA DO BATERII RETRO GRUPA I

	Indeks	wymiar	cena netto	pak
	0611.975		4,84	-

KRZYWKA DO BATERII GRUPA II

	Indeks	wymiar	cena netto	pak
	0611.921	wzmocniona	9,22	4/300
	0611.920		7,98	6/600

WYLEWKA DO BATERII – C – 3/4" φ18 GRUPA I

	Indeks	wymiar	cena netto	pak
	0611.430	L-16	23,06	1
	0611.431	L-20	23,88	1
	0611.432	L-25	24,68	1
	0611.433	L-30	25,90	1

WYLEWKA DO BATERII – S – 3/4" φ18 GRUPA I

	Indeks	wymiar	cena netto	pak
	0611.420	L-16	23,06	1
	0611.421	L-20	23,88	1
	0611.422	L-25	24,68	1
	0611.423	L-30	25,90	1

WYLEWKA DO BATERII – ELASTYCZNA GRUPA I

	Indeks	wymiar	cena netto	pak
	0611.442	niebieska	73,08	1
	0611.449	czarna	73,08	1
	0611.445	biała	73,08	1
	0611.446	beżowa	73,08	1
	0611.447	grafit	73,08	1
	0611.448	szara	73,08	1

ELASTYCZNA WYLEWKA DO – BATERII ŚCIENNEJ GRUPA I

	Indeks	wymiar	cena netto	pak
	0611.439	czarna	100,48	1

KOMPLET MONTAŻOWY DO BATERII GRUPA II

	Indeks	wymiar	cena netto	pak
	0615.405	1 otworowej	3,00	-
	0615.406	2 otworowej	3,10	-

PRZEŁĄCZNIK DO BATERII WANNOWEJ STANDARD/RETRO GRUPA II

	Indeks	wymiar	cena netto	pak
	0611.951	standard/retro	34,58	1

SIODEŁKO GRUPA II

	Indeks	wymiar	cena netto	pak
	0611.987	-	11,26	1

UCHWYT DO BATERII GRUPA II

	Indeks	wymiar	cena netto	pak
	0611.965	40 (pełna)	29,94	1
	0611.966	35 (pełna)	29,94	1
	0611.967	35 (otwór)	29,94	1

POKRĘTŁA DO BATERII pięciokątne chrom wieloklin 20 GRUPA I

	Indeks	wymiar	cena netto	pak
	0611.970	niebieskie	11,98	1
	0611.971	czerwone	11,98	1



Goshe Sp. z o. o.
ul. Zientary-Malewskiej 41A, 10-307 Olsztyn
tel. +48 89 664 327 590

info@goshe.pl
www.goshe.pl

Wersja cennika: **01/2026 z dnia 23.03.2026**

Niniejszym Cennik nie stanowi oferty w rozumieniu przepisów Kodeksu Cywilnego i jest tylko informacją wstępną. Do zawarcia indywidualnej umowy może dojść wyłącznie po uzgodnieniu istotnych jej postanowień. Równocześnie producent zastrzega sobie prawo do prowadzenia zmian i modyfikacji cen z względu na zmiany kursu walut, a także zmian wynikających z mogących wystąpić błędów lub pomyłek.